

CSZ

Cincinnati Sub-Zero

EZT-570S

Environmental Chamber Controller User Manual









    11/30/2015 4:50 PM ▼  					
PV	39.1	PV	78.9	PV	39.6
SP	50.0	SP	85.0	SP	50.0
%	-14.8	%	57.9	%	0.0
C	TEMPERATURE	%RH	HUMIDITY	C	PRODUCT
Manual Operation			Program Operation		

TABLE OF CONTENTS

1. Overview 6

1.1 Safety Information..... 6

1.1.1 Device Under Test (DUT) Safety Information 6

1.2 About the EZT-570S 7

1.3 Touch Screen Interface 8

1.4 Menu Navigation 9

1.4.1 Home Menu 10

1.4.1.1 Text Based Home Menu 10

1.4.1.2 Icon/Slide Page Based Home Menu..... 11

1.4.2 System Settings Menu 12

1.4.2.1 Text Based Device Settings Menu 12

1.4.2.2 Icon/Slide Page Based Device Settings Menu 13

1.4.3 Data Menu 14

1.4.3.1 Text Based Data Menu 14

1.4.3.2 Icon/Slide Page Based Data Menu..... 15

1.4.4 Offline Menu 16

1.4.4.1 Text Based Offline Menu 16

1.4.4.2 Icon/Slide Page Based Offline Menu 17

1.5 Notifications 18

2. Monitoring 19

2.1 Main (Loop) View 19

2.2 Overview 20

2.3 Trends..... 21

2.3.1 Trend Setup..... 22

2.4 Alarm Monitor 23

2.4.1 Pumpdown..... 23

2.4.2 Help for Alarms..... 24

2.5 Alarm History 25

2.6 System Status Monitor..... 26

3. Manual Operation..... 27

3.1 Set Point Adjustment 27

3.2 Manual Operation (Turning the Chamber On/Off)..... 28

3.2.1 Standard Chamber Options..... 29

3.2.1.1 Humidity Operation 29

3.2.1.2 Auxiliary Cooling Operation 30

3.2.1.3 Dry Air Purge/Low RH Operation 30

3.2.2 Special Chamber Options 31

3.2.2.1 Altitude Operation 31

3.2.2.2 Thermal Shock Transfer Mechanism Operation..... 31

3.2.2.3 Defrost Operation 32

3.2.2.4 Remote Set Point Operation..... 32

3.2.3 Product Control Option..... 32

3.2.4 Customer Events Option 33

4. Automatic Ramp/Soak Program Operation 34

4.1 Entering a Ramp/Soak Program..... 35

4.1.1 Entering Step Time..... 35

4.1.2 Entering Step Set Points 36

4.1.2.1 Entering Ramp Rate 37

4.1.3	Setting Step Events	38
4.1.4	Setting Guaranteed Soak Events	39
4.1.5	Using Wait For	40
4.1.6	Using Jumps	41
4.1.7	AutoStart	42
4.1.8	Guaranteed Soak Limits	42
4.2	Program Plot	43
4.2.1	Program List	43
4.3	Starting an Automatic Ramp/Soak Program	44
4.3.1	Hold/Resume Ramp/Soak Program Operation	46
4.4	Monitoring Automated Ramp/Soak Program Operation	46
4.4.1	Advance Previous/Next Step	47
4.4.2	Adjusting Step Time	47
4.5	Program Worksheet	48
4.6	Frequently Asked Questions About Ramp/Soak Program Operation	49
5.	System Settings	51
5.1	Recovery	51
5.2	Set Point Limits	52
5.3	Event Names	52
5.4	Alarms	53
5.4.1	Set Points and Alarm Message	54
5.5	Product Control	56
5.5.1	Using Product Control	57
5.5.1.1	Should I Use Product Control for My Test	57
5.5.1.2	Implementing Product Control on “Dead Loads”	58
5.5.1.3	Implementing Product Control on “Live Loads”	59
5.5.1.4	Considerations When Applying Product Control	60
5.5.1.5	How do I Know when Product Control is Active?	60
5.6	Condensation Control	61
5.7	Defrost Settings	62
5.8	Communication Settings	63
5.8.1	10/100 Base-T Ethernet Settings	64
5.9	Barcode Reader	65
5.9.1	Barcode Reader Communication Settings	66
5.9.2	Important Notes on Barcode Reader Use	66
5.9.2.1	Using the Barcode Reader to Start an Automatic Ramp/Soak Program	66
5.9.2.2	Using the Barcode Reader to Annotate a Data Log File	66
5.10	Email	67
5.10.1	Address Entry	67
5.10.2	Email Addresses	67
5.10.3	Email Settings	68
5.10.4	Sending Email Messages	70
5.11	Navigation	71
5.12	Tuning	71
6.	Security	74
6.1	Adding Users	75
6.2	Viewing Users	75
6.2.1	New Password Entry	76
6.3	Setting User Access	76
6.3.1	User Access Rights	77
6.4	Setting Security Options	79
6.5	Audit Trail	80

7. Data Logging	81
7.1 Selecting Points for Logging	82
7.2 Start/Stop Data Logging	82
7.2.1 Calculating Log File Size	84
7.3 Reviewing Historical Data	84
7.3.1 History Plot Setup	84
7.3.2 Plotting Historical Data	85
7.4 USB File Transfer	86
7.4.1 Recommended File Maintenance	88
7.5 FTP Data Backup	89
7.5.1 More About FTP, FileWeb and DataWeb Interfaces	91
7.5.2 FileWeb/DataWeb Server Components and Requirements	93
7.6 CSZutil.com Web site for FTP, FileWeb and DataWeb Testing	93
7.7 Annotation	98
7.8 Digital Signatures	99
8. Offline	100
8.1 Service	101
8.1.1 Service Options	102
8.2 Degrees C/F Selection	103
8.3 Clock Settings	104
8.3.1 Time Options	104
8.3.1.1 Local Time Server Settings	105
8.3.2 DST Settings	105
8.4 Language	106
8.5 Special Settings	107
8.6 Hardware	107
8.6.1 Analog Inputs	107
8.6.1.1 Enabling Remote Set Point Inputs	108
8.6.1.2 Analog Input Wiring	109
8.6.2 Analog Outputs	110
8.6.2.1 Analog Output Wiring	111
8.6.3 Digital Inputs	112
8.6.3.1 Digital Input Wiring	115
8.6.4 Digital Outputs	116
8.6.4.1 DUT Safety Relay Output Wiring	118
8.6.4.2 Digital Output Wiring	118
8.7 Monitor Offset Calibration	120
8.7.1 Refrigeration Monitor Option	121
8.8 Display Settings	121
8.8.1 Calibrate Touch	121
8.8.2 Backlight Settings	123
8.9 Configuration	124
8.9.1 Cloud Server Settings	125
8.10 About the EZT-570S	127
8.11 Exit Application	128
9. Communications	129
9.1 Serial Communications	130
9.1.1 Adjusting Modbus Serial Communication Settings	130
9.1.2 EIA-232 Connections	131
9.1.3 EIA-485 Connections	131
9.2 GPIB (IEEE-488) Communications	133
9.2.1 GPIB Command Structure	134



9.3	10/100 Base-T Ethernet Communications.....	135
9.3.1	Guidelines of Smart Networking Practice.....	135
9.3.2	The EZT-570S and Network Security	136
9.3.3	Using the Web Server	137
9.3.4	Using the VNC Server.....	139
9.3.4.1	Recommended VNC Viewer Settings (PC/MAC)	139
9.3.4.2	Recommended VNC Viewer Settings for Tablets	141
9.3.4.3	Accessing the EZT-570S through a VNC Viewer.....	142
9.3.5	Using Modbus TCP/IP Communications.....	144
10.	Diagnostics	145
10.1	Alarm Codes and Troubleshooting	146
10.2	Service Monitors	150
A.	Appendix.....	152
	FTP, FileWeb, DataWeb Requirements/Installation	
	Common Terms and Definitions	
	List of Figures	

1. Overview

This manual has been tailored to cover all of the specific features and options available on the EZT-570S environmental chamber controller. Not all options and/or features may be available on your particular chamber. It is highly recommended that you read this manual thoroughly and understand all aspects of the EZT-570S controller prior to operating your chamber.

1.1 Safety Information

Note, caution and warning symbols that appear throughout this manual are to draw your attention to important operational and/or safety information.

-  A **“NOTE”** marks a short message to alert you to an important detail.
-  A **“CAUTION”** safety alert appears with information that is important for protecting your equipment and performance.
-  A **“WARNING”** safety alert appears with information that is important for protecting you, others and equipment from damage. Pay very close attention to all warnings that apply to your chamber.

1.1.1 Device Under Test (DUT) Safety Information

The environmental chamber is equipped with high heat limits and/or safety devices. These devices are installed to protect the chamber from exceeding design limits. These devices remove power from the chamber’s heaters only and DO NOT remove power from the device under test.

Provisions must be made by the end user to de-energize the tested device with the chamber in order to prevent an over-temperature condition and subsequent damage to the chamber and/or device under test. For this reason, the chamber is equipped with a DUT safety relay (24V AC/DC, 2A maximum resistive load) that should be connected to the device’s power supply control circuit at a minimum. This relay will open and de-energize the device under test whenever the chamber is not operating (see Section 8.6.4.1 DUT Safety Relay Output Wiring).

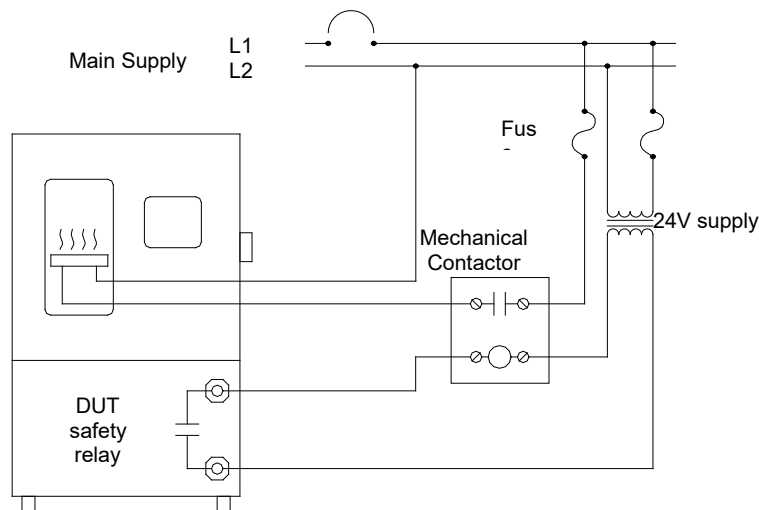

Figure 1-1 DUT Safety Connections

1.2 About the EZT-570S

The EZT-570S environmental chamber controller combines all of the features of typical loop controllers, video/chart recorders and data logging systems into a single/intuitive device. Email (supporting SSL/TLS), SMS (text messaging), FTP, FileWeb, DataWeb (file transfer protocols for automated data backup and web database interface) and remote viewing/control (via Web server/VNC server) are standard with the EZT-570S and can be accessed via LAN/WAN using a PC, tablet or smart phone device.

The EZT-570S allows the chamber to be operated in single set point or automatic ramp/soak program control modes. Program entry is made easy through the use of copy, paste, and delete menu selections. Programs can be copied to the external 'USB' memory stick and then imported to another EZT-570S controller which eliminates the need to enter duplicate ramp/soak programs into multiple chambers.

Data file analysis tools (auto-trend) make looking at historical data a simple task. Any control variable saved to the EZT-570S SD memory can be plotted on the historical data trend, for any time frame within the data file's total time range.

The built in Ethernet functionality includes a 'Web Server' to provides access to all EZT-570S data (view only), a VNC interface for remote control and monitoring and an NTS clock, all available via a local Intranet connection (wired or wireless), or the World Wide Web using standard software like Microsoft's Internet Explorer.

The EZT-570S provides a rich set of tools for control interaction and data analysis. Views include system overviews, trends, alarms, automatic programs as well as historical data, alarm history and audit trail views. The icon driven interface eliminates screen 'clutter' by providing an easy to use 'Smart Device' interface for interaction between the user and the EZT-570S.

The EZT-570S can store more than one year of data on its SD memory card. Data logging can be enabled manually or automatically during ramp/soak program operation. Data backup is provided by a USB memory stick for plug and play transfer of files to any PC or via the FTP back-up utility.

The EZT-570S protects system access with 4 level security (user rights based), audit trails that document all user activity and ensures data integrity by digitally signing all data files and audit trails to meet regulatory requirements.



The graphic displays shown in this manual are representative of those on a standard temperature and humidity chamber. The screens and examples shown within may vary slightly from your chamber based on installed options and type of chamber.

1.3 Touch Screen Interface

The EZT-570S display is split into two sections; the icon bar and main display area.

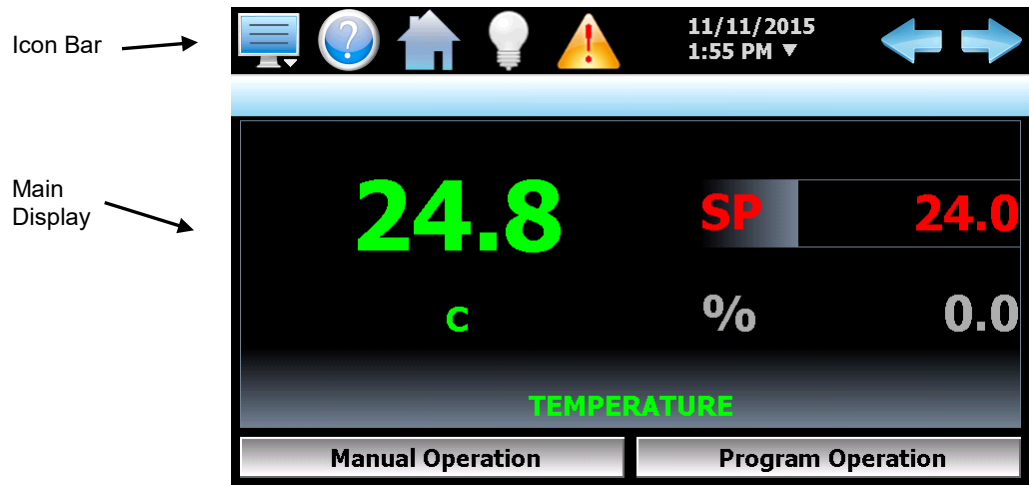

Figure 1-2 Touch Screen Interface



The menu icon will open the main menu for navigating to the different control and monitoring screens. Menu items will dynamically appear providing available options based on the system area the user is in, i.e., security, data logging, setup, etc.



The information (help) icon will display text-based help associated with the current screen. Help is available in 28 languages based on the user selection in the offline setup of section of the EZT-570S.



The home icon will return the user to the main view from anywhere in the EZT-570S application.



The alarm icon will appear and flash when a new system alarm occurs. Pressing the alarm icon will take the user directly to the alarm screen in order to view and/or reset the active alarm condition.



The light icon allows the user to turn the chamber light(s) on and off.



The left and right navigation arrows will appear on screens that provide additional information that the user can scroll to such as the main view screen, real time trends or program entry screen in order to cycle through each step of a ramp/soak program.



A single press of the left or right arrows will scroll program steps to the next step or screens to the next available loop or trend. Pressing and holding the arrow keys will continue the scrolling until the last step of the program is reached or the button is released.

1.4 Menu Navigation

The EZT-570S provides the user with the ability to select text-based menu navigation, much like the typical file menu system of a PC, as well as an icon-based navigation system like that of a “smart” device. The user can switch back and forth between the two from the System\Settings menu.

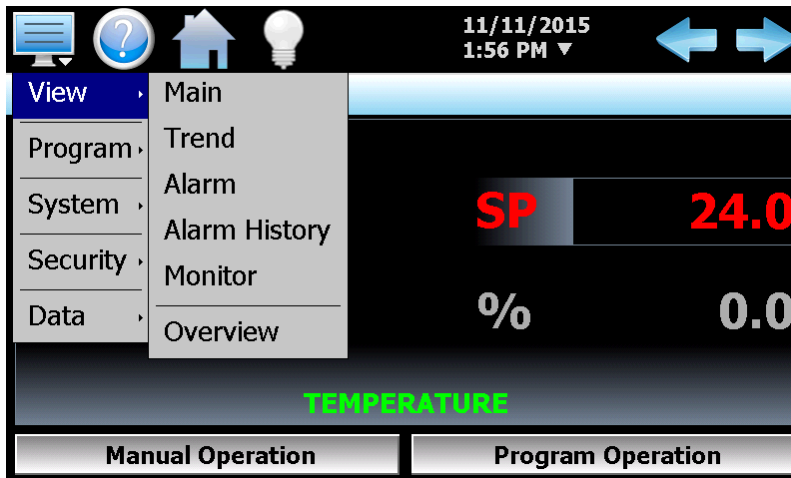

Figure 1-3 Text Based Navigation

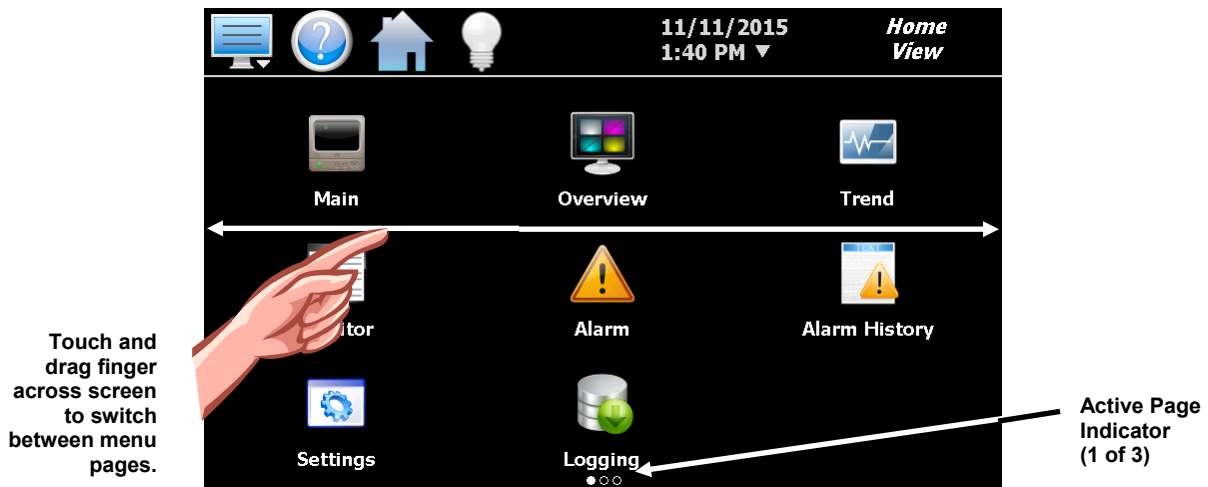

Figure 1-4 Icon Based/Slide Navigation

The available menu items are dependent upon the options installed on the chamber. Not all of the menu items shown may be available on chamber. The following information is provided as an overview of the full navigational menus for the EZT-570S.

- ⚠ **Do not use any sharp or metal objects on the touch screen as they may damage the surface. Oil and/or solvents on hands and fingers will mar the touch screen surface. Do not use chemicals to clean the surface of the touch screen. A soft, damp cloth is all that is necessary.**

1.4.1 Home Menu

The home menu is the top level, default menu provided when the chamber and the EZT-570S first powers on. Pressing the menu icon will display the main menu offering the selections shown below.

1.4.1.1 Text Based Home Menu

View	›	Main
Program	›	Trend
System	›	Alarm
Security	›	Alarm History
		Monitor
Data	›	Overview

The **View** menu provides navigation to all standard view screens. These include the Main loop view, real time Trend, Alarm monitor, Alarm History, status Monitor and Overview control screen.

View	›	
Program	›	Status
System	›	Entry
Security	›	Plot
Data	›	

The **Program** menu provides access to the program Entry and Status views. It also provides access to the program Plot screen which allows the user to view the entire program under edit in either a graph or list format.

View	›	
Program	›	
System	›	Settings
Security	›	
Data	›	

The **System** menu provides access to the EZT-570S controller settings. These include, loop set point entry limits, alarm settings, communication settings, email setup as well as access to offline settings for date/time, etc.

View	›	Settings
Program	›	Login
System	›	Log Off
Security	›	Audit Trail
Data	›	User
		Password

The **Security** menu provides access for user login, security settings and audit trail viewing if the security system is enabled.

View	›	
Program	›	
System	›	
Security	›	
Data	›	Logging

The **Data** menu provides access to data log functions, file utilities, FTP/WAN back-up settings as well as the historical data viewer.

1.4.1.2 Icon/Slide Page Based Home Menu

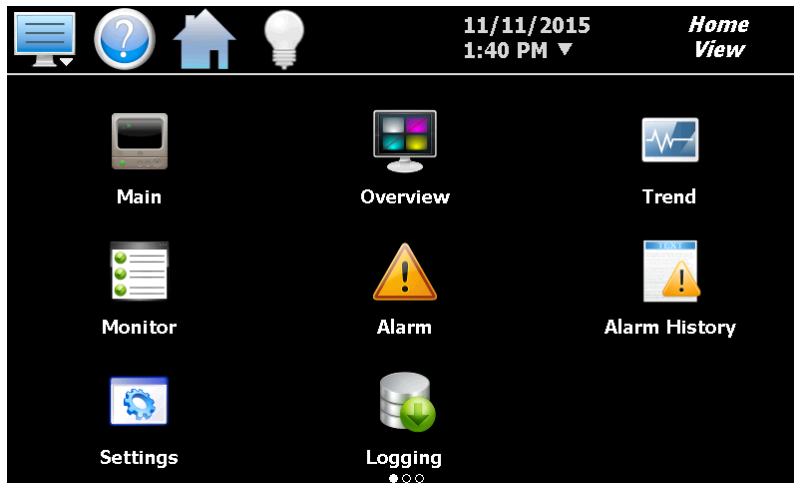

Slide page 1 provides navigation to all standard view screens. These include the Main loop view, Overview, Trend, status Monitor, Alarm, and Alarm History screens.

It also provides access to the EZT-570S Settings and data Logging sections.

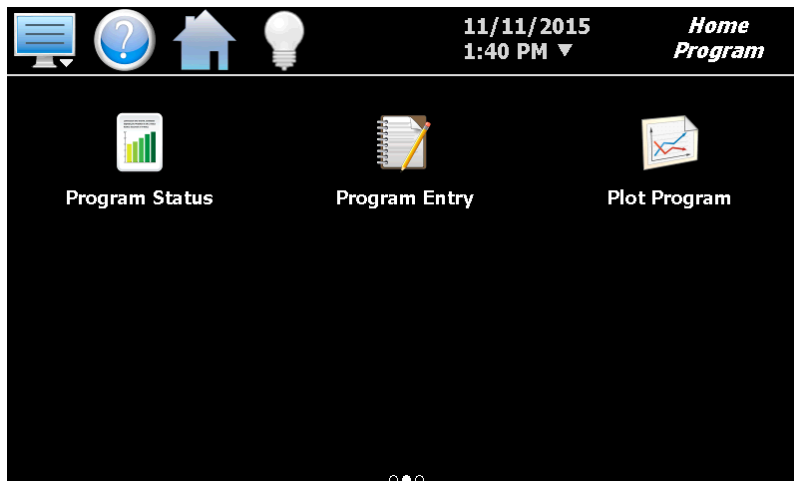

Slide page 2 provides access to the program Entry and Status views.

It also provides access to the Plot Program screen which allows all steps of the current program under edit to be viewed in graph or list format.

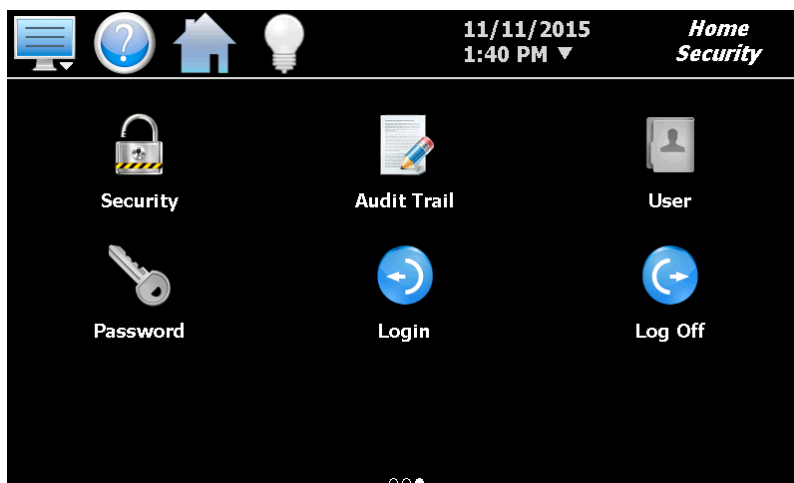

Slide page 3 provides access to security settings, Audit trail, User information, Password editing and user Login and Log Off functions.

1.4.2 System Settings Menu

The system settings menu is provided when “Settings” is selected from the home “System” menu. See section 5 on System Settings for detailed information on these settings and their use.

1.4.2.1 Text Based Device Settings Menu

View	Tuning
Setup	Defrost
Comms	Condensation
Email	
Offline	

The **View** menu provides navigation to the Tuning, Defrost and Condensation control screens.

View	Alarms
Setup	Setpoint Limits
Comms	Product Control
Email	Event Names
Offline	Recovery
	Navigation

The **Setup** menu provides access to the setup screens for Alarms, Setpoint Limits, Product Control, customer Event Names, power recovery, and Navigation.

View	
Setup	
Comms	User
Email	Barcode
Offline	

The **Comms** menu provides access to the User communications settings for the web page, VNC server and Modbus user communications as well as settings for the optional Barcode reader.

View	
Setup	
Comms	
Email	Settings
Offline	Message

The **Email** menu provides access to the Settings screen for the email server to send SMS text messages and/or emails on alarm. It also allows the user to compose and send messages to any user configured in the system from the Message screen.

View	
Setup	
Comms	
Email	
Offline	Settings

The **Offline** menu provides access to the EZT-570S offline settings screens which provide the user with the ability to adjust the date/time, calibrate the touch screen, configure digital and analog IO, etc.

1.4.2.2 Icon/Slide Page Based Device Settings Menu

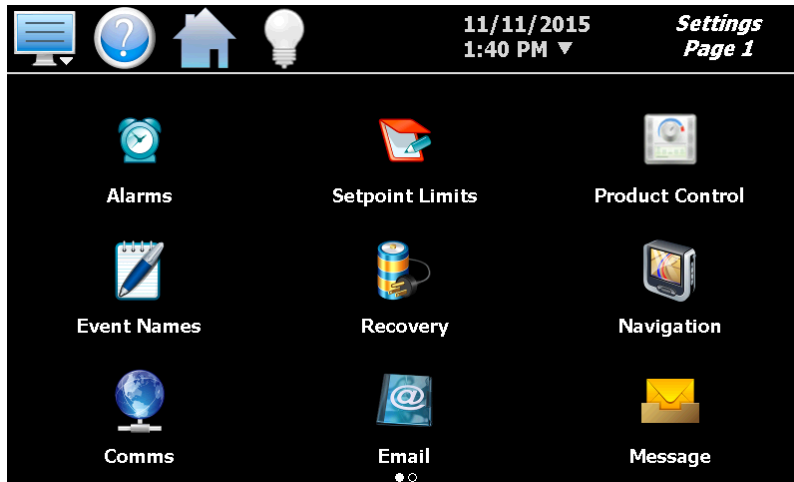

Slide page 1 provides access to the settings screens including options for Navigation type, setpoint Limits, Alarm setup, Event tagname entry, power Recovery, Product control, email server settings and messaging.

It also includes access to the communications settings for the web page, VNC server and user Modbus communications.

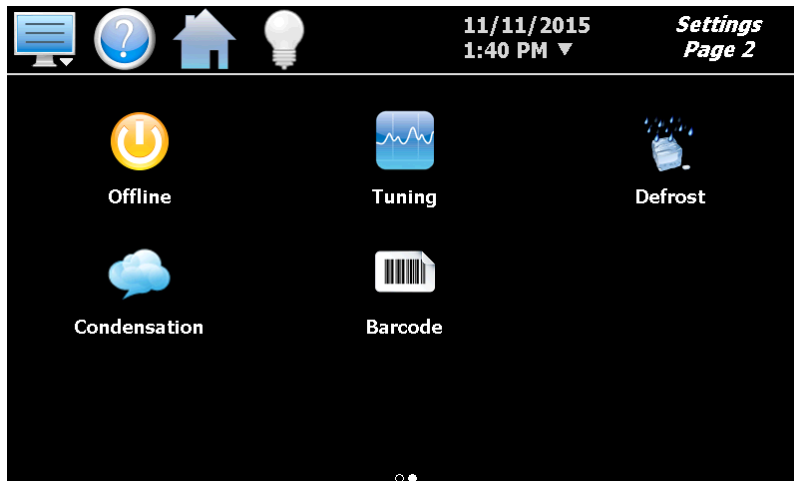

Slide page 2 provides access to the EZT-570S offline setup screens which provide the user with the ability to adjust the date/time, calibrate the touch screen, configure digital and analog IO, etc.

It also includes access to the optional Barcode reader and Condensation control and Defrost setup screens.

1.4.3 Data Menu

The data log menu is provided when “Logging” is selected from the home “Data” menu. See section 7 on Data Logging for information on these settings and their use.

1.4.3.1 Text Based Data Menu

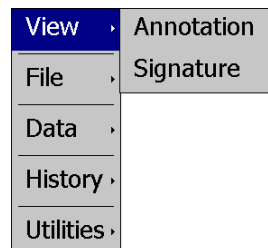

The **View** menu provides access to the data file Annotation and digital Signature screens.

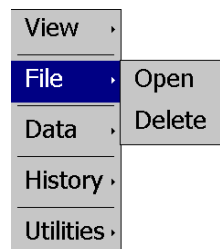

The **File** menu provides functions for opening and deleting historical data files.

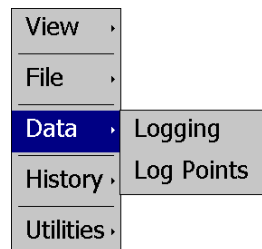

The **Data** menu provides access to the main Data screen for starting and stopping data logging and to the log point Assignment screen where the user can select which items are to be logged to the history file.

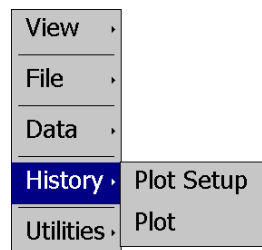

The **History** menu provides functions for viewing historical data files in graphical format.

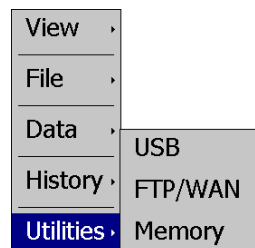

The **Utilities** menu provides access to the EZT-570S file management utilities including USB file transfer and FTP/WAN back-up.

1.4.3.2 Icon/Slide Page Based Data Menu

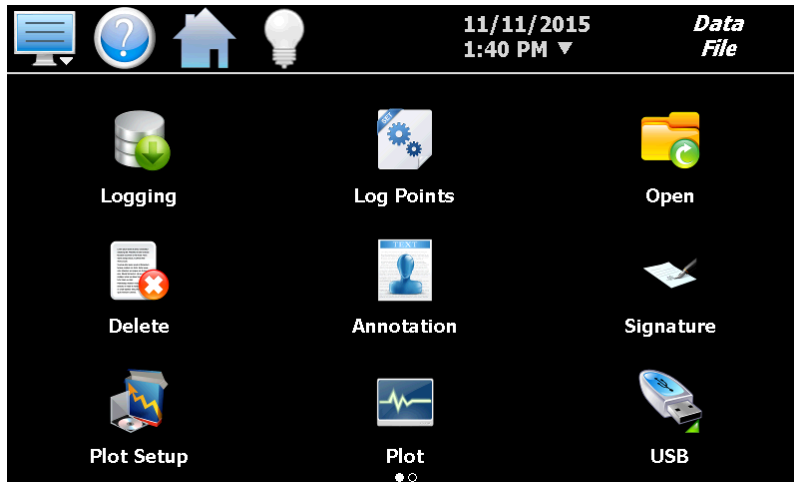

Slide page 1 provides access to the main Logging and Log Points assignment screens.

Historical data file functions are provided for Opening and Deleting historical files as well as viewing/setting data file Annotations and digital Signatures.

The Plot Setup and Plot icons provide access to the data viewer options.

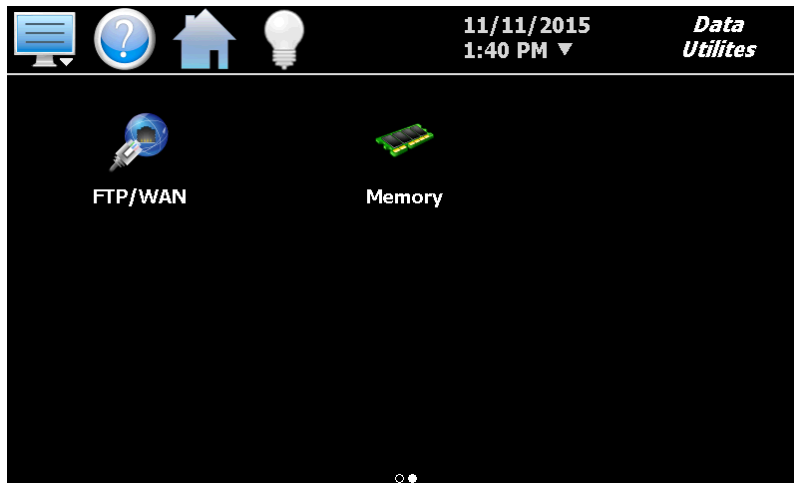

Slide page 2 provides access to the FTP/WAN back-up settings and the memory check utility for viewing the available system/storage memory space.

1.4.4 Offline Menu

The offline menu is provided when “Settings” is selected from the system settings “Offline” menu. See section 8 on Offline Settings for information on these settings and their use.

! *Offline settings can only be accessed when a ramp/soak program is not running and data logging is turned off. When entering offline setup, the EZT-570S will go ‘offline’. This means that all outputs and control functions will stop and be disabled. If the chamber’s operation cannot be interrupted due to an active test, do not enter offline mode.*

1.4.4.1 Text Based Offline Menu

View	Settings
Setup	Service Counters
Hardware	Service Options
Calibrate	
System	

The **View** menu provides navigation back to the online system settings menu and to the Service Counters and Service Options screens.

View	
Setup	Units
Hardware	Clock
Calibrate	Language
System	Special

The **Setup** menu provides access to the temperature Units selection, Clock, Language selection and Special settings.

View	
Setup	
Hardware	Analog Input Analog Output
Calibrate	Digital Input
System	Digital Output

The **Hardware** menu provides configuration access to the EZT-570S optional digital and analog inputs and outputs.

View	
Setup	
Hardware	
Calibrate	Offset
System	

The **Calibrate** menu provides access to apply an offset to the optional monitor inputs.

View	
Setup	
Hardware	Display Configuration
Calibrate	About
System	Exit

The **System** menu provides access to the EZT-570S Display settings, import/export Configuration utility, About screen and Exit application screen.

1.4.4.2 Icon/Slide Page Based Offline Menu

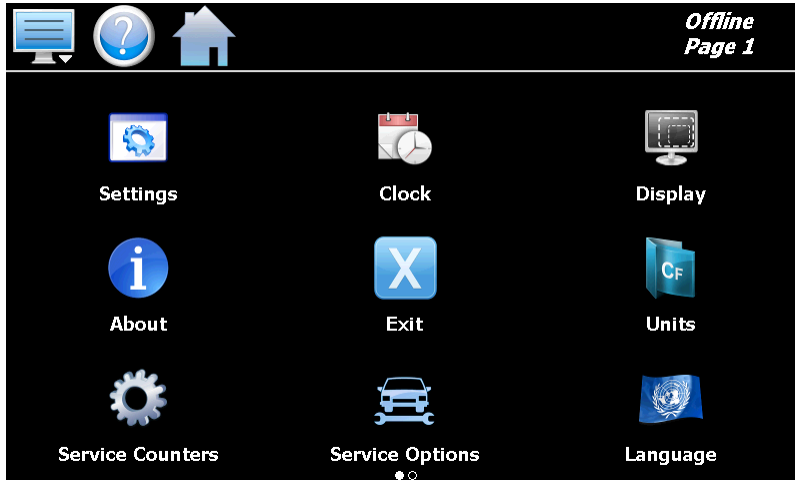

Slide page 1 provides navigation back to the system settings menu, temperature Units, Clock, Service Counters and Service Options, Display settings and Language selection.

It also provides access to the About and Exit application screens.

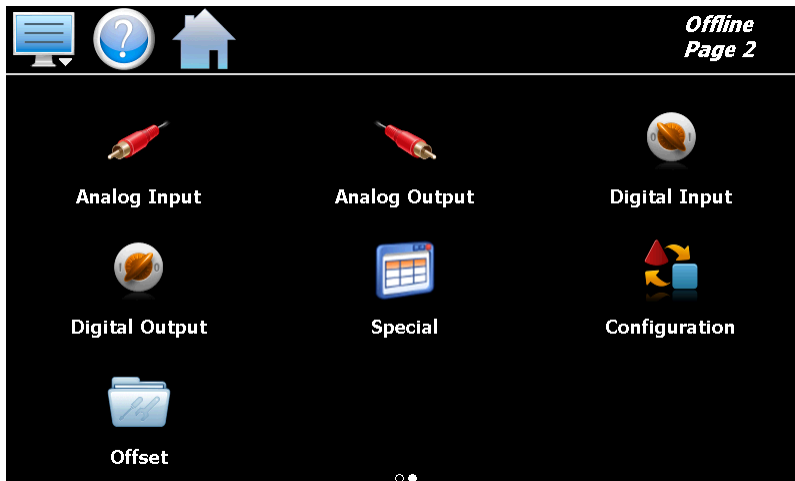

Slide page 2 provides configuration access to the optional EZT-570S digital and analog inputs and outputs.

It also provides access to the monitor input Offset screen, Special settings and the Configuration import/export utility.

1.5 Notifications

The notification window is a feature that can be accessed by pressing the date/time field in the icon bar. This window provides a snapshot of current activity. The notification window can be closed by pressing the date/time field again, or is automatically closed if the Menu, Home, Alarm or left or right arrow icon is pressed.

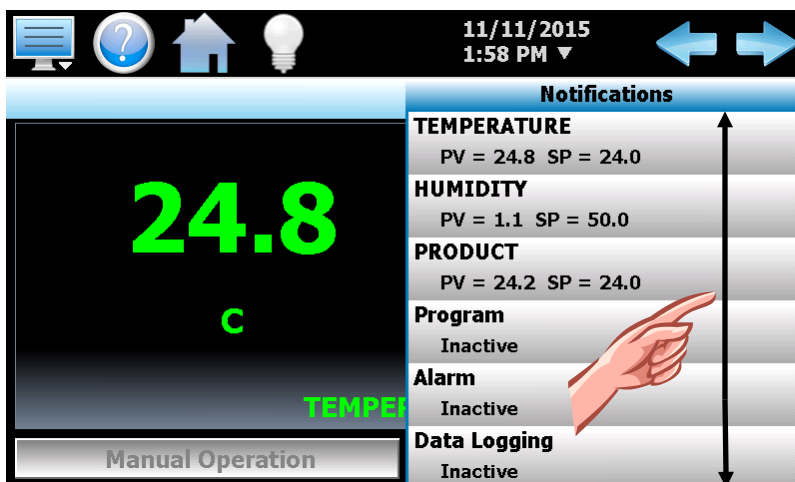

Figure 1-5 Notifications

All available notifications can be viewed by touching the screen and dragging a finger up or down on the list to scroll through all items like all other lists in the EZT-570S. The notifications include the following:

- Loop PV and SP for each loop.
- Monitor PV for each monitor point (if option installed on chamber).
- Automatic program status including name of running program.
- Defrost operational status (if chamber equipped with defrost).
- Active alarm status including the most recent alarm.
- Data logging status including active file name and the length and logging rate set.
- Security status including the current user.
- Audit trail active/inactive status.
- Web server active/inactive status.
- VNC server active/inactive status.
- EZT-570S IP address.
- Available SD storage memory remaining.



The notification items do not update while the list is shown. The information shown in the list is a snapshot of the data at the time the window was shown. Therefore, the PV or SP shown for a loop may not be the actual values for the loop if the notification window is left open for extended periods of time. The notification window is not available under offline settings.

2. Monitoring

The home menu view screens provide various means of verifying chamber operation and performance. The Main loop view screen provides different viewing options for the control and monitoring of chamber processes such as temperature, humidity, altitude, etc. If the loop is a monitor input, the set point and percentage of output will not be displayed since no control is associated with the input.

In order to view the temperature or humidity over time, the EZT-570S provides real-time trends. Eight user configurable trends are provided with up to eight user selectable plot points each. In addition, the EZT-570S provides system status and alarm views to inform the user of any issues that arise with chamber operation.

2.1 Main (Loop) View

The Main loop view can be configured to show from one to five control loops and/or process monitor inputs at a time. The number of loops that are displayed can be set by the user under the System\Settings\Navigation screen. See section 5.11 Navigation for more information.

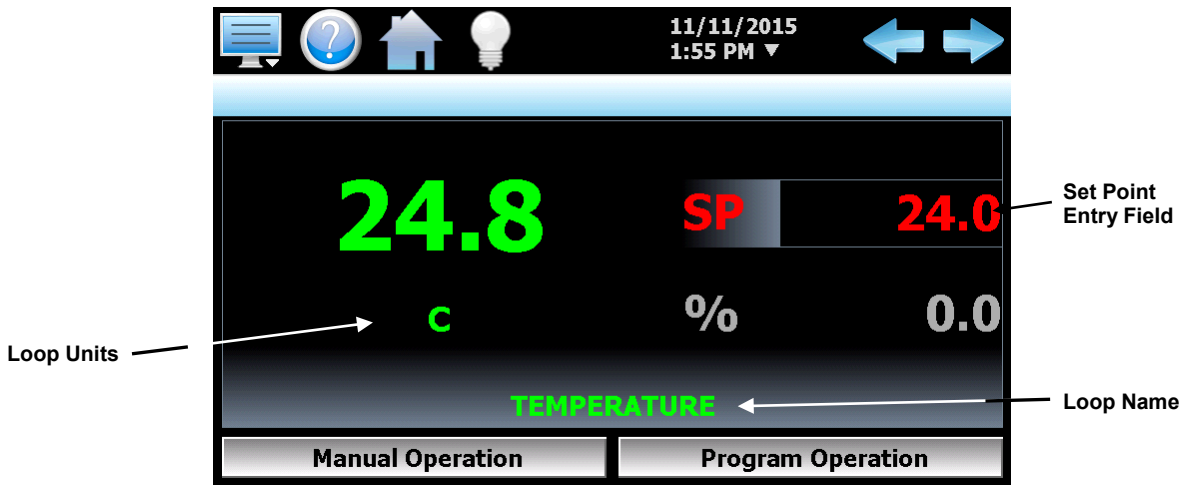

Figure 2-1 Main View (one loop)

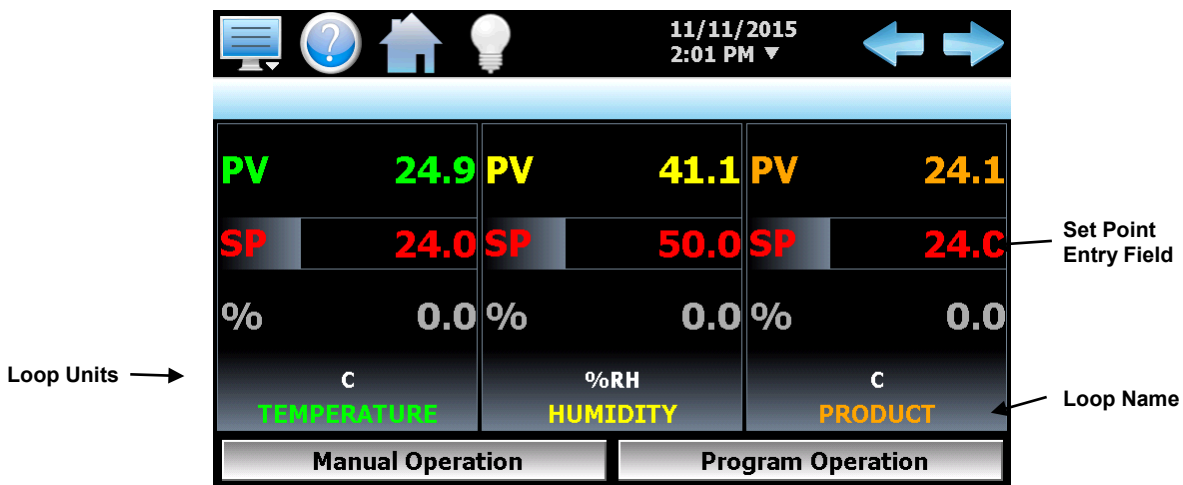

Figure 2-2 Main View (three loop)

The **left** and **right arrow buttons** at the top right corner of the screen will cycle through each loop and monitor point available. By pressing either button, the previous or next loop will appear in sequential order.

When the first or last loop is reached, the EZT-570S will automatically wrap around to the beginning or end of the list to show the next loop. If the number of loops configured in the system matches the number shown on the screen, the arrow buttons will not be shown as there are no additional loops or monitor points to scroll to.

The **loop name** will update as each loop or monitor point is selected. The unit display field will update as well, in order to provide the user with the units of measurement for the selected loop or monitor point.

The **set point entry field** is the area where the screen can be touched in order to bring up the keypad entry window. Using the numeric entry keypad, a new set point can be entered. Once entered, the new set point will be shown in the set point entry field. Adjustment of the set point is locked out if an automatic ramp/soak program is in operation.

The **Manual Operation** button displays the manual event control window. This provides access to all of the chamber and customer events allowing the operator to turn the chamber and other systems on and off directly from the main screen. See section 3.2 Manual Operation for more information.

The **Program Operation** button displays the automatic ramp/soak program control window. This provides access to program select, start, stop and hold functions allowing the operator to control the program directly from the Main screen. See section 4.3 Starting an Automatic Ramp/Soak Program for more information.

2.2 Overview

The Overview screen provides access to the chamber and customer events as well as a convenient way to view all control loops and monitor inputs.

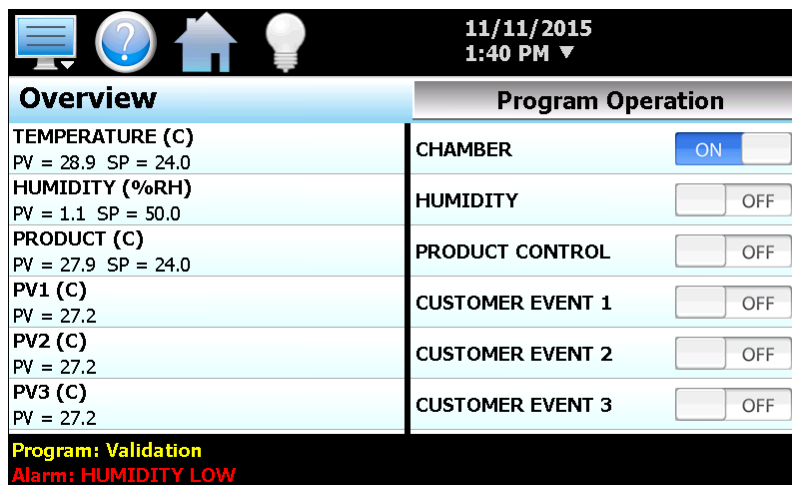

Figure 2-3 Overview

The Overview screen contains two scrolling lists. The list on the left contains all loop and monitor information. To change the set point of a loop, touch the row of the desired loop. The numeric keypad will then be shown allowing a new set point to be entered.

The list on the right contains the system events. To turn the system events on and off, press the on/off button for the event that you want to turn on or off to toggle the on/off state of the event.

The currently loaded program, or status of a running ramp/soak program will be displayed at the bottom left of the screen. The Overview will also display all current alarms that have not been cleared from the Alarm screen. The alarm field will automatically scroll through each alarm, displaying one at a time every few seconds until all alarms have been cleared.

The **Program Operation** button displays the automatic ramp/soak program control window. This provides access to program select, start, stop and hold functions allowing the operator to control the program directly from the Overview screen. See section 4.3 Starting an Automatic Ramp/Soak Program for more information.

2.3 Trends

The real-time trends can be configured to display the set point (SP), process variable (PV) and percentage of output (%) of control loops and the process variable of monitor points over a selectable period of time. The vertical axis determines the range of displayed data while the horizontal axis determines the history period. The maximum time period that can be shown in a trend is 24 hours.

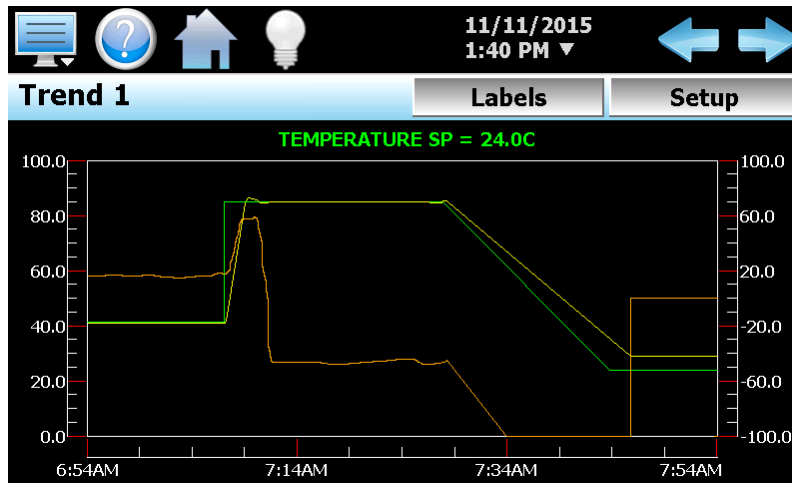

Figure 2-4 Real-Time Trend

The rate at which the trend plots a new point is based on the time period to be shown. Each buffer can hold a total of 720 readings for each of the selected channels to plot. The update rate can be calculated by the formula: $\text{time period (in minutes)} * 60 / 720$. Note that for time periods less than 72 minutes, the update rate will be held to a minimum of 6 seconds. Thus, the update rate will vary from a minimum of 6 seconds (for time periods of 72 minutes or less) up to a maximum of 120 seconds for 1440 minutes (24 hours).

The **Labels** button cycles through each of the configured plot channels to determine what each colored plot represents as well as view the current value without having to return to the loop view screens. The left and right scroll buttons at the upper right of the screen are used to cycle through each of the eight available charts.

The trends also allow a user to “zoom in” on a particular area to have a more detailed look at current data. By using a finger to select an area on the screen, the trend will zoom in on that area. To select a portion of the plot, touch and hold the screen with a finger or stylus. Drag the stylus across the trend and a box will be drawn around the selected area. Removing the stylus from the screen will cause the trend to redraw with only the selected plot area. To return to the normal view, touch the ‘X’ or ‘Y’ axis and select zoom out to return to the previous zoom setting or zoom normal to return to the full display.

! *When a trend is “zoomed in” it will not update with new information. The trend must be in normal view mode in order to update at each time interval. The trend will return to normal view automatically when selecting a different trend or screen to view.*

If the EZT-570S clock updates for daylight savings time, or is corrected to the proper time by the NTS server, the offset in time may cause the trend to display data inaccurately due to this time offset. The trend will automatically correct itself once the buffer is cleared of this data. The clock is updated at 2 am., so with a buffer length of 4 hours for example, the trend data will display accurately at 6 am.

2.3.1 Trend Setup

To configure a trend, press the “Setup” button to display the trend setup screen. To assign plot channels to the trend, simply touch the on/off button for the desired items in the list to select them. Select the left or right vertical axis for each item by selecting the item in the list and press the button for the desired “Left” or “Right” axis. The left axis is the default axis selection. If none of the plot channels are assigned to the right axis, the axis will not be shown on the trend.

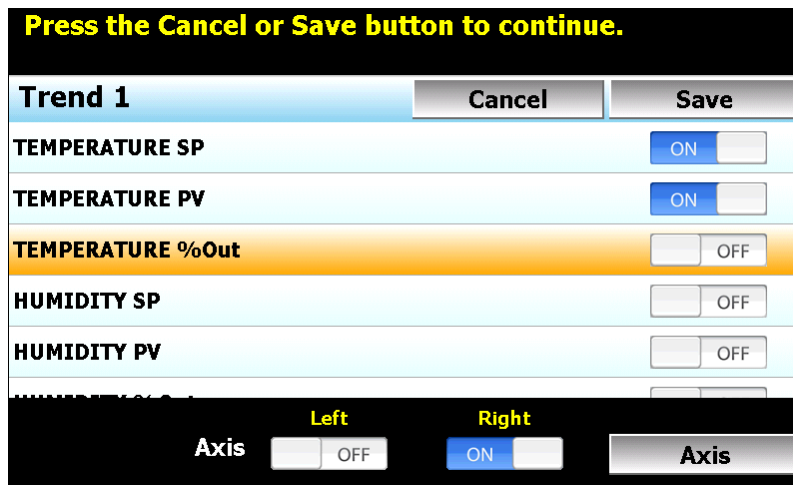

Figure 2-5 Trend Setup

Once the channel selections have been made, press the “Axis” button to adjust the time period and vertical axis range of the trend.

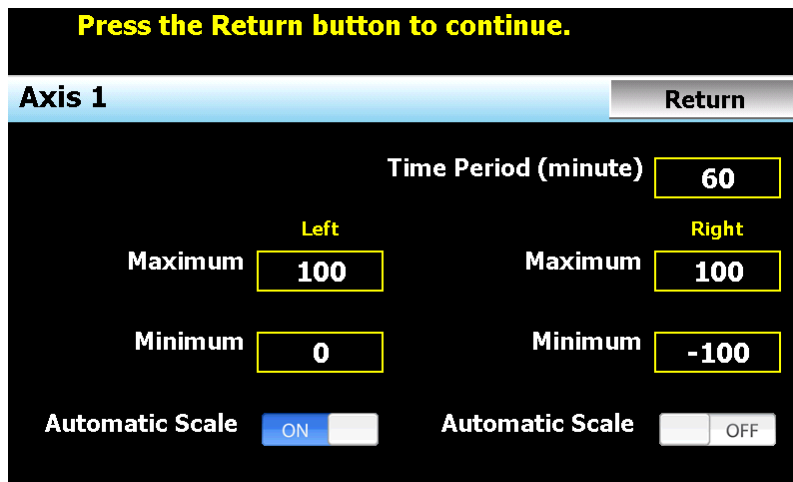

Figure 2-6 Trend Time/Axis

Time Period - Adjusts the displayed time period for the graph. The allowable range is from 4 to 1440 minutes (24 hours).

- Maximum -** The maximum value sets the maximum range of the vertical access with a minimum value of -32,760 and a maximum of 32,760.
- Minimum -** The minimum value sets the minimum range of the vertical access with a minimum value of -32,760 and a maximum of 32,760.
- Automatic Scale -** When on, the vertical axis will automatically adjust its zero and span as needed to display the selected plot channels.

2.4 Alarm Monitor

The alarm screen displays any current and/or previously silenced alarms according to time and date of occurrence. On each new alarm occurrence, the alarm icon in the menu bar will flash to notify the user of a new alarm. Once the alarm is reset, the alarm icon will be hidden; however, the alarm condition may still be present. The chamber will not restart until all alarms have been reset and the alarm condition has cleared.

If the chamber does not restart upon reset of the alarm, verify that all manual reset safeties have been reset and the alarm condition has been cleared by pressing the “Clear” button. This will remove all alarms that have been reset from the list. If the alarm is still present, the alarm condition still exists and must be corrected in order for the chamber to resume operation.

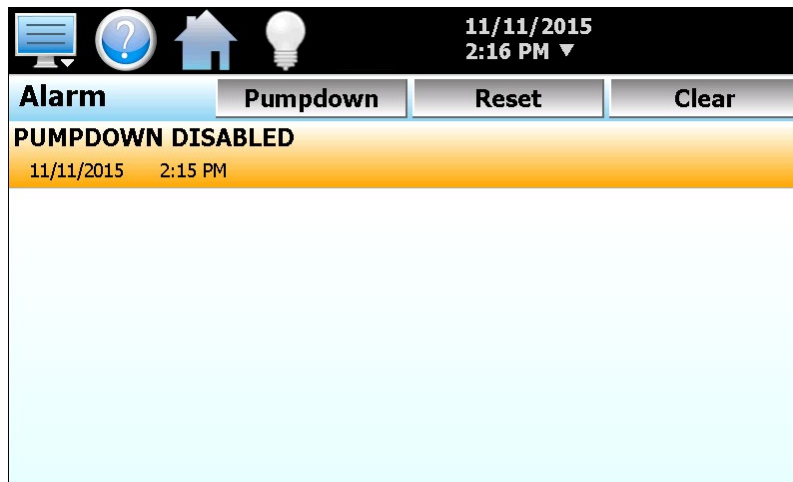

Figure 2-7 Alarm Monitor

2.4.1 Pumpdown

Chambers with large horsepower refrigeration systems have an automatic mode of operation called “pumpdown”. The refrigeration system is in this mode whenever it is not running to cool or dehumidify the chamber. In pumpdown mode, the system 1 compressor will automatically turn on and off at preset pressures in order to force refrigerant into the high side of the system. This serves as a means to protect the compressor on start-up.

If pumpdown was not used, refrigerant could migrate throughout the system and accumulate, typically in the coldest location like the compressor crankcase. On start-up, this refrigerant could then enter the compressor as a liquid and cause permanent damage to the compressor. In addition, a crankcase heater is installed on the compressor in order to heat the oil in the crankcase of the compressor. This helps boil out any refrigerant, so that it can be pumped into the high side of the system.

If the chamber is equipped with the pumpdown mode of operation, the “Pumpdown” button will be provided on the Alarm screen if pumpdown is disabled. This provides a manual way to reset pumpdown mode. Pumpdown will be automatically disabled if main power is off for more than 30 minutes. This is due to the fact that without main power, the crankcase heater will be off and cannot warm the compressor. Depending on the temperature of the compressor, this could allow refrigerant to accumulate in the compressor causing a potentially damaging start-up.

The “Pumpdown Disabled” alarm will notify the operator of this condition. The chamber will not operate when pumpdown is disabled. Pumpdown will automatically reset after the main power has been on for a period of 4 hours or it can be reset at any time by pressing the “Pumpdown” button.

! If your chamber is equipped with pumpdown, main power should remain on at all times. If power is removed for extended periods of non-use, DO NOT reset pumpdown after power is applied to the unit. Only silence (reset) the alarm. Allow the 4 hour warm-up period prior to use or damage to the compressor may result.

2.4.2 Help for Alarms

The EZT-570S provides alarm specific help to assist the operator in determining what caused an alarm and how it may be corrected. To view the help for an alarm, select the alarm from the alarm list by touching the alarm’s description. The selected alarm will then be highlighted orange as shown in Figure 2-7.

Once the alarm is selected, press the help icon in the menu bar. The help screen will then be shown with information relating specifically to the alarm.

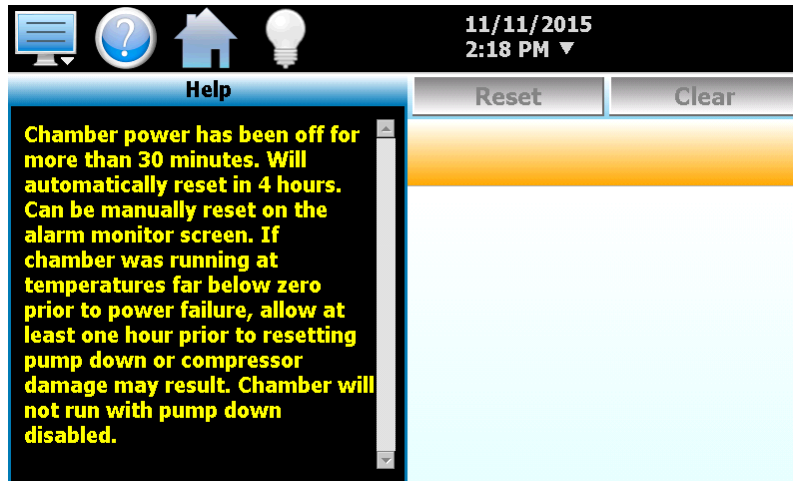

Figure 2-8 Alarm Help

If alarm specific help is not available for the selected alarm, the standard “system alarm help” will be provided. See Section 10, Diagnostics, for alarm codes and corrective actions.

2.5 Alarm History

The Alarm History screen displays all alarms for any given day. The EZT-570S can store daily alarm files for a period of a year or longer (time based on storage usage for data logging). Each time an alarm occurs, the alarm is written to a file. Alarm file names are listed as MMDDYYYY (where MM = month, DD = day, YYYY = year). The “Open” file button will display a dialog box where the user can select any alarm file to view.



If no alarms occurred on a given day, an alarm file will not be created for that day. The alarm list will display up to 650 alarm files. If more than 650 alarm files are present, the alarm files cannot be shown in the list and the files will have to be exported from the EZT-570S in order to view them. This can be done either via USB file utilities (see section 7.4) or FTP (see section 7.5).

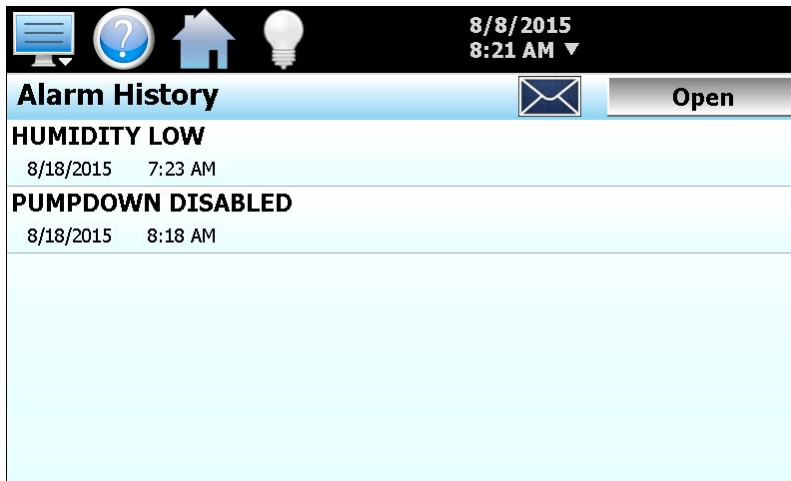



Figure 2-9 Alarm History

The send email icon  provides the ability to send a copy of the currently opened alarm file to any of the email addresses entered into the EZT-570S. When the email icon is pressed, an “Add Recipients” window will be displayed where the user can select recipients for the file from any of the email addresses configured under the EZT-570S email settings. For information on how to add email recipients to EZT-570S, see Section 5.10, Email.

2.6 System Status Monitor

The Monitor screen provides status information and alerts to indicate specific operational conditions or limits that have been reached in the chamber's operation.

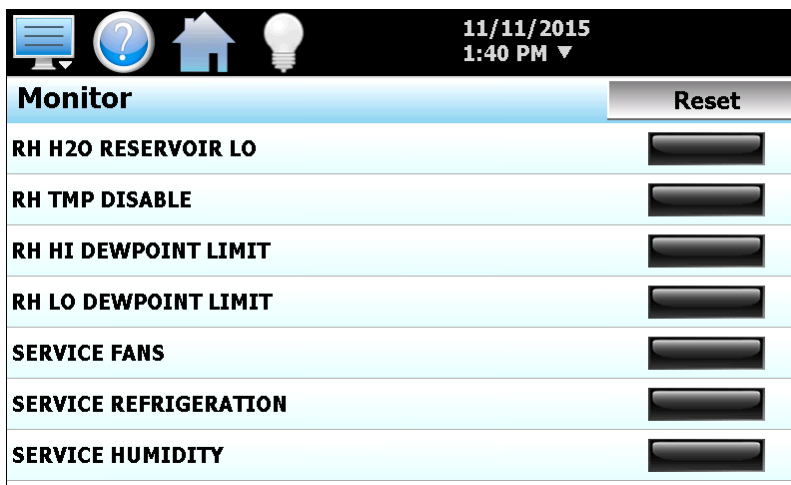



Figure 2-10 System Status Monitor

The LED next to the system status description will be green to indicate that the status is active. Alerts that require operator attention, such as the low water reservoir or a service notification, will be indicated by an intermittent beeping of the chamber's audible alarm. The alarm icon will also flash. Pressing the alarm icon while one of the alerts is active will automatically display the Monitor screen for user convenience. The alert can then be silenced through the use of the "Reset" button. See Section 10, Diagnostics, for alarm codes and corrective actions.

- 
If an alarm is currently active or there is an alarm that had previously occurred and was reset but not cleared from the alarm screen, pressing the alarm icon will always navigate to the alarm screen. System alarms take priority over the status alerts. The EZT-570S will always direct the user to the alarm screen if an alarm is present in the list.

3. Manual Operation

The EZT-570S controller can function as either a static (single) set point controller or as an automatic ramp/soak program controller. The EZT-570S is in static mode (single set point operation) when it is not running a ramp/soak program. This section describes how to operate the chamber in this mode.

3.1 Set Point Adjustment

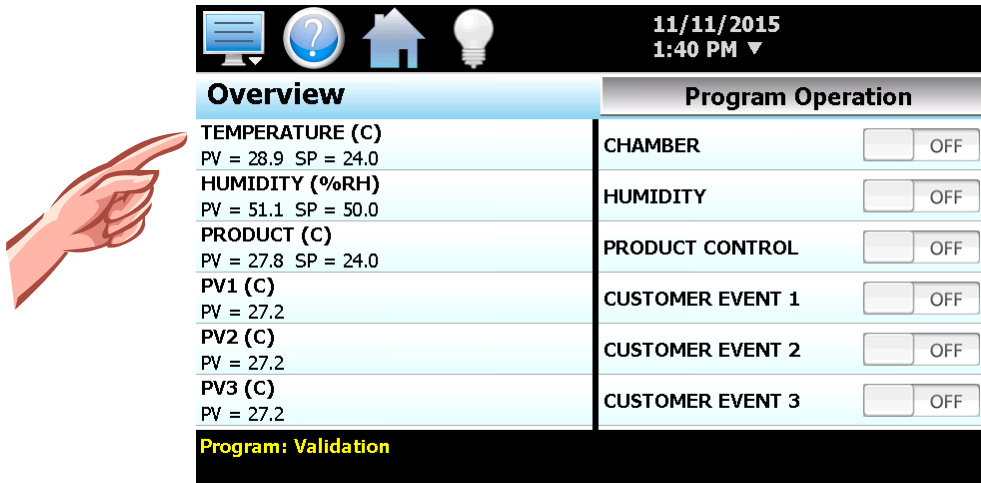

Figure 3-1 Single Set Point Adjustment

To adjust a set point:

1. Select either the Main loop view or Overview screen from the home View menu.
2. Touch the set point for the desired loop on the Main screen or select the loop row from the list on the Overview screen. The numeric keypad will be shown. Enter the desired set point value and press the "Enter" button.

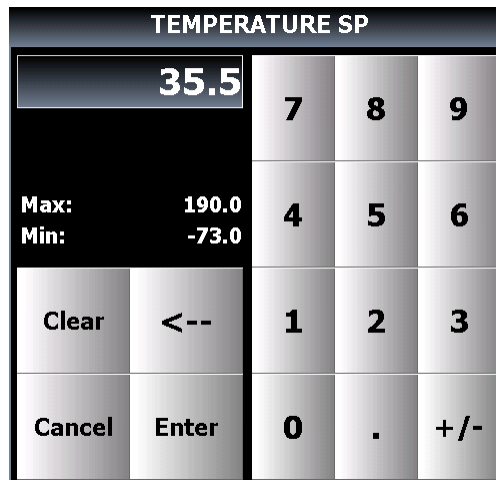

Figure 3-2 Numeric Entry

3. Turn on the Chamber event. See the following Section 3.2, Manual Operation.

3.2 Manual Operation (Turning the Chamber On/Off)

Events are the “switches” used to turn the chamber, its related functions, and optional systems on and off. These events can be manually turned on and off as well as programmed into ramp/soak programs so that they can be turned on and off at set time intervals.

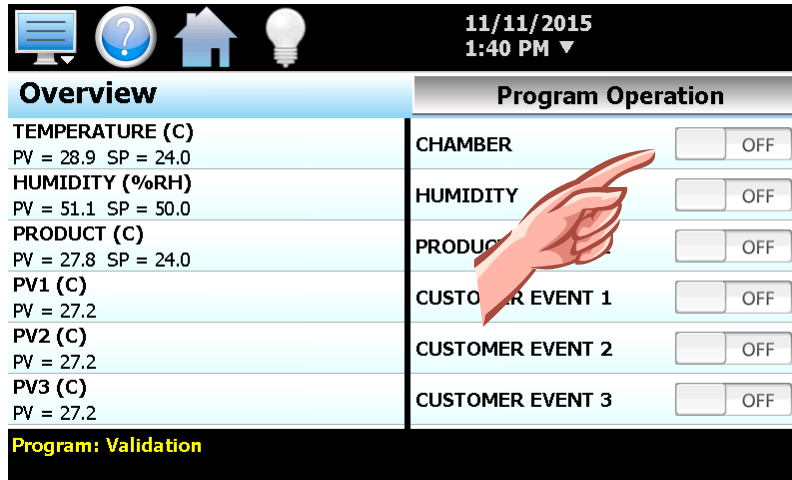

Figure 3-3 Manual Event Control (Overview)

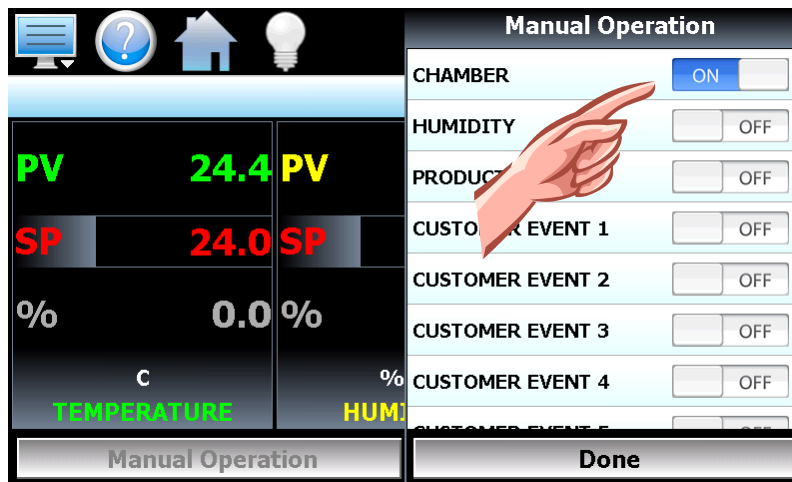

Figure 3-3 Manual Event Control (Main)

To turn the chamber and optional events on/off:

1. Select “Overview” from the home View menu or press the “Manual Operation” button on the Main loop view screen.
2. Touch the on/off button for each event to toggle it on and off.
3. Press the “Done” button on the “Manual Operation” window once the desired events have been set to close the window and return to the Main loop view.

3.2.1 Standard Chamber Options

The first event is the “switch” that turns the chamber on and off. This will enable air circulators, pumps, heating/cooling systems and any other components associated with the operation of the chamber. This event is present on all chambers. Depending on the options provided with your chamber, additional events may also be present.

3.2.1.1 Humidity Operation

The humidity event turns the chamber’s humidity system components on and off. Note that when humidity is turned off, the relative humidity is still measured and displayed; however, no control takes place to obtain the set point value. The humidity system will not operate unless the chamber event is also turned on.

The operating limits of the humidity system are dependent upon actual chamber temperature and chamber construction. *Please **note** the following regarding humidity system operation:*

Temperature Extremes

When operating your environmental chamber at extreme air temperature, below freezing (0°C / 32°F) or above boiling (100°C / 212°F), the chamber is not capable of controlling humidity. This is due to the physical properties of air and its ability to hold moisture at standard atmospheric pressures when at these temperatures.

To prevent malfunction or damage to the chamber, the EZT-570S control system automatically disables the humidity system components when outside of the valid operating temperature range. The event will remain on; however, so once the air temperature in the chamber returns to the valid operating range, humidity control will resume at the target humidity set point.

When humidity is disabled due to the chamber air temperature, the corresponding system status Monitor indicator (RH TMP DISABLE) will illuminate to indicate that this condition is present.

Minimum Humidity Limitations

The standard humidity option provides a lower limit of humidity control relating to a 4.4°C (40°F) dewpoint. The dewpoint refers to the temperature at which the air contains the maximum amount of moisture it can hold. When a surface drops to that temperature or below, condensation will occur on that surface. The dewpoint varies logarithmically with temperature and relative humidity. This means that at higher temperatures, a much lower humidity level can be obtained because the air can hold more moisture the warmer it becomes.

For example, an air temperature of 85°C (185°F) and relative humidity of 12% is the equivalent dewpoint of air at a temperature of 5°C (41°F) and 79%. Both of these values are at the minimum achievable dewpoint of the chamber, and thus the minimum achievable humidity at the related temperature. If you were to set the humidity set point at 0% for example, the humidity level would never reach 0 since the chamber is not capable of removing any more moisture from the air.

The EZT-570S is programmed to determine what the minimum achievable humidity point is at any given temperature and will control to that limit. Therefore, the system will not overwork itself trying to reach an unattainable point. This prolongs system life, reduces wear and tear and prevents damage to humidity system components. Thus, if you set a set point of 0%, you can be confident that the environment within the chamber will remain as dry as possible at any given temperature within the operating range.

When humidity is limited due to the fact that the minimum dewpoint has been achieved, the corresponding system status Monitor indicator (RH LO DEWPOINT LIMIT) will illuminate to indicate that this condition is present. If your chamber is not obtaining the desired humidity level, check the status monitor to verify that you are not trying to operate the chamber at a point outside of the chamber’s minimum dewpoint capability.

Maximum Humidity Limitations

Certain chambers have limitations on the maximum humidity level that they can operate at a given temperature in order to protect the chamber structure. This limit typically applies to modular chambers. These chambers are constructed of individual panels that lock together to form the chamber. The panels have an inner chamber liner and outer skin with a foam insulation sandwiched between them. They are primarily used for large walk-in/drive-in chambers. Due to the materials used in the construction of the modular panels, the humidity is typically limited to a maximum 70°C dewpoint which corresponds to a maximum of 95% at 70°C (158°F).

When humidity is limited due to the fact that the maximum dewpoint has been achieved, the corresponding system status Monitor indicator (RH HI DEWPOINT LIMIT) will illuminate to indicate that this condition is present. If your chamber is not obtaining the desired humidity level, check the status monitor to verify that you are not trying to operate the chamber at a point outside of the chamber's maximum dewpoint capability.

3.2.1.2 Auxiliary Cooling Operation

The auxiliary cooling system utilizes LN2 or CO2 as a boost cooling medium to assist the refrigeration system in lowering the chamber air temperature. It is an inexpensive method for fast cooling transitions without having to make the investment in a high horsepower refrigeration system that may rarely be used. It can also be used as the primary cooling source for ultra-low temperature operation on chambers designed to operate at temperatures below -84°C (-120°F)

When this option is installed on the chamber, turn the "Aux Cooling" event on. When the boost is required during a pull down, the EZT-570S will automatically turn on the boost cooling solenoids and inject LN2 or CO2, into the chamber to rapidly drop the temperature as required. Once the desired set point is achieved, the boost solenoids will close in order to conserve LN2 or CO2 since it is no longer required, and allow the refrigeration system to maintain the chamber air temperature.

If the chamber is designed for ultra-low temperature operation, and the set point is below the minimum achievable temperature for the refrigeration system, the EZT-570S will disable the refrigeration system and use the boost cooling system for the primary cooling source. This automatically protects the refrigeration system from damage and optimizes system operation.

If the auxiliary cooling event is turned off, the only means of cooling will be from the refrigeration system. If the set point is below the capabilities of the refrigeration system on an ultra-low temperature chamber, the chamber will not be able to reach set point until the event is turned on.

3.2.1.3 Dry Air Purge/Low RH Operation

The dry air purge event can provide two levels of operation.

Level 1 - The first level of operation is dry air purge only. The purge only option consists of an air dryer which dries a small volume of air and discharges the dry air within the chamber work space. This helps reduce condensation on surfaces within the chamber by drying the air. When this event is turned on with the purge only option, the air dryer will run continuously until the event is turned off. Note that the chamber event must also be on in order for purge to operate.

If the chamber is also equipped with the humidity option and the humidity system is enabled, the purge system will be disabled automatically by the EZT-570S. The humidity system cannot control the humidity level within the chamber if the purge system is continuously trying to dry out the chamber. However, if the humidity set point is below the minimum achievable humidity (low dewpoint limit), the EZT-570S will turn the dry air purge back on in order to achieve the lowest possible humidity level.

Level 2 - The second level of this option includes the frozen coil (low RH) option. This option allows the chamber to reach a -29°C (-20°F) dewpoint. This relates to lower relative humidity capabilities at a given air temperature. When the low RH option is installed and the humidity system is enabled, the dry air purge system is automatically operated in conjunction with the frozen coil by the EZT-570S controller based on the air temperature and humidity set points. When required to obtain low humidity levels, the frozen coil and dry air purge systems will start in order to achieve the target set point. When no longer required, they will automatically turn off.

This level of operation also provides the benefit of being able to manually use the dry air purge system by turning the purge event on and off. However, in the case where the low RH option is installed, the humidity system must be disabled for the dry air purge to function manually.

3.2.2 Special Chamber Options

Depending upon the type of chamber or installed options, there are several other events that may be listed on the manual event screen. They will be used in conjunction with the optional equipment to initiate or control the process related to that option.

3.2.2.1 Altitude Operation

The altitude event turns the chamber's altitude system components on and off. Altitude chambers are specifically built to withstand atmospheric pressures. They have heavy gauge liners with additional internal structure for reinforcement. They simulate altitude by utilizing a vacuum pump to draw air out of the chamber and may also use compressed air to increase chamber pressure if altitudes below site level are required.

The EZT-570S can provide a direct pressure reading in Torr (millimeters of mercury) or convert the resultant pressure within the chamber into feet, which allows the altitude set point to be entered directly in feet. The altitude system can operate independently of the chamber conditioning system; thus, the chamber event does not have to be on for the altitude system to operate.

Chamber Temperature Control Limitations

As altitude increases, the air density within the chamber decreases. The heating and cooling systems require a minimum amount of air flow in order to operate correctly and control the internal chamber air temperature. The altitude system will inhibit the operation of the heating and cooling systems when the altitude increases beyond the design limits. This limit is typically around 65Kft.

Humidity Control Limitations

On most altitude chambers with the humidity system option, operation of the humidity system is inhibited when the altitude system is enabled. The vacuum system used to control the internal chamber pressure, cannot operate with the addition of moisture. Only altitude chambers with vacuum systems specifically designed to operate with the presence of moisture will allow humidity control with the altitude system enabled.



Unless the vacuum system was specifically designed to operate in conjunction with humidity, the chamber must be dried out before entering into altitude operation. Any standing water in the chamber must be eliminated or possible damage and premature failure of the vacuum pump may occur.

3.2.2.2 Thermal Shock Transfer Mechanism Operation

For chambers designed to perform specific thermal shock testing, a transfer cart/basket is used to shuttle the product under test between different extreme environments. The transfer mechanism typically transfers between two or three different zones.

The location for the shuttle to transfer to is set by two or three events which describe the desired location. Vertical thermal shock (VTS) chambers typically operate with a hot and a cold chamber. The events then relate to these locations as “XFR HOT” or “XFR COLD”. Double duty thermal shock (DTS) chambers, also shuttle product between hot and cold chambers; however, these chambers are equipped with a center cold chamber and two outer hot chambers. Since DTS chambers shuttle product from left to right and vice versa, the events describe the transfer positions as “XFR LEFT” and “XFR RIGHT”. Liquid bath thermal shock (TSB) chambers typically include a third position which is an ambient zone. The “ambient” zone removes the basket from the liquid baths and allows the operator to load product into the basket. This position uses the “UNLOAD” event.

When a position event is selected, the other event(s) will be automatically turned off and the basket will transfer to the selected location. If there is a failure in the mechanism and the basket does not reach its intended position, the “TRANSFER ERROR” alarm will indicate this fault. The selected transfer event will then be turned off automatically, and the transfer mechanism will not try to transfer the shuttle again until the operator enters a new position selection.

Manual Transfer Selection

When operating thermal shock chambers, the typical operation involves transferring product from a “hot side” to a “cold side”. Since the transfer event selections work like “radio buttons”, that is when one is pressed the other turns off, you can use this for repetitive manual transfers without having to select and deselect the different events.

For example, if you set the “User State” to “ON” for both the transfer hot and transfer cold events, each time the update button is pressed, the selected position for the transfer mechanism will alternate back and forth between the hot and cold chambers.

Automatic Program Transfer Selection

When running a ramp/soak program, only one transfer position should be selected in a step. In most cases, since the object of the test is to cycle between two chambers with fixed temperature conditions, a two or three step program is all that is required. Each step will have the same set points, but the transfer cart position events will alternate between the two steps.

3.2.2.3 Defrost Operation

If the chamber is equipped with the hot-gas defrost option, the “INITIATE DEFROST” event will allow for programmed or manually initiated defrost of the chamber’s cooling coil(s). See Section 5.7 Defrost Settings, for more information on using the defrost option.

3.2.2.4 Remote Set Point Operation

If the chamber is equipped with the analog input (remote set point) option, there will be an event listed for each available input. When the event is enabled, “REMOTE SETPOINT 1, REMOTE SETPOINT 2”, etc., it will enable that input. The input will then drive the set point for the loop it is set to control. See Section 8.6.2 Analog Inputs, for more information on configuring and using the remote set point inputs.

3.2.3 Product Control Option

Most chambers are equipped with a product control loop. The “PRODUCT CONTROL” event can be used to enable/disable product control programmatically through a running ramp/soak program or just manually via the manual event screen. See Section 5.5 Product Control, for more information on settings and use of this feature.

3.2.4 Customer Events Option

The EZT-570S controller has the ability to control up to 15 event output relays. These outputs can be manually turned on and off or controlled programmatically through a running ramp/soak program. They can be used to start and stop devices under test within the chamber, turn signal beacon lights on and off to indicate different steps within the test cycle, etc. In order for the EZT-570S's optional digital outputs to function as events, they must be configured to do so. By default, the digital outputs, when available, are configured as customer event outputs. See Section 8.6.3 Digital Outputs, for more information on setting the operational mode for the optional digital outputs.

4. Automatic Ramp/Soak Program Operation

A ramp/soak program is a set of instructions (set points and events) programmed as a timed sequence of steps. When a program is run, the EZT-570S executes each step of the program automatically, in sequence, based on the time duration and settings for each step. The EZT-570S can store hundreds of automatic ramp/soak programs (depending on storage usage for data logging) with up to 99 steps in each program.

The program entry toolbar provides the following functions for editing programs:

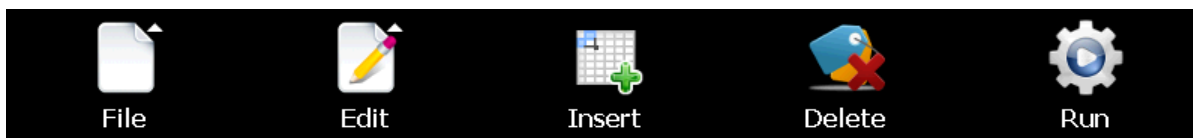

New
Open
Save
Save As
Delete
Export

File menu button

- New: Clears all current program entries.
- Open: Provides file open dialog to select a program from memory.
- Save: Saves the current program being edited.
- Save As: Saves the program being edited under a new name.
- Delete: Deletes the current program from internal memory.
- Export: Copies the program being edited to USB memory stick.

Copy Step
Paste Step
Same Events
G-Soak Limits
AutoStart

Edit menu button

- Copy Step: Copies current step data including events.
- Paste Step: Pastes previously copied step data to the current step.
- Same Events: Copies and pastes current step events to all following steps.
- G-Soak Limits: Displays the guaranteed soak limits screen.
- AutoStart: Displays the auto start settings screen.

Insert step button

Inserts a step after the current step. Upon insert, the EZT-570S will copy the current step set points and events and automatically fill in the data for the newly inserted step. This speeds program entry by minimizing the number of entries a user has to make such as eliminating the need to set the same events on each step of the program. Only the time for the new step and set points (if ramping to a new value) need to be entered.

Delete step button

Deletes the current step.

Run button

Displays the program operation window to allow the user to start the program under edit or select or control an existing program. See section 4.3 Starting an Automatic Ramp/Soak Program for more information.

4.1 Entering a Ramp/Soak Program

Ramp/Soak programs are created and edited from the Program Entry screen. To create an automatic ramp/soak program:

1. On the Program Entry screen, press the File menu button, select “New” to create a new program.
2. Enter the data for step 1 of the program.

! *The first step of a program is an “initialization” step meaning that the loop set points will immediately go to the set points entered for the step and stay there for the duration of the step when the program is started. This ensures that the program will always start from the same conditions each time it is run.*

3. For each additional step required, press the Insert button to add a step. Make any required changes to the step time, set points, events and wait for conditions.
4. Once entry is complete, press the File menu button and select “Save” to save the program.

! *Programs can be saved with names of up to 16 characters long. However, the EZT-570S only uses the first 10 characters of the program name for display updates and record keeping. When naming programs, try to keep the name limited to 10 characters in order to have the full program name shown, or use the first 10 characters as a means of more clearly identifying the program if more than 10 characters are used in the name.*



Figure 4-1 Program Entry

4.1.1 Entering Step Time

The length of time, loop set points and jump conditions for each step are entered by touching the corresponding row for the desired entry in the list on the left side of the Program Entry screen. To enter the time for the step, press the first row in the step data list view that contains the time entry. Upon doing so, the numeric entry keypad will be shown.

The length of each step is entered as a period of time in hours, minutes and seconds. To make time entry easy, the entry will automatically be formatted into time as the number keys are pressed. For example, if a step is to be thirty seconds long, just enter a value of 30. If the time for the step is one minute and thirty seconds, enter a value of 130 for 1 minute, 30 seconds. If the step time is one hour and thirty minutes, enter a value of 13000 for 1 hour, 30 minutes and 00 seconds.

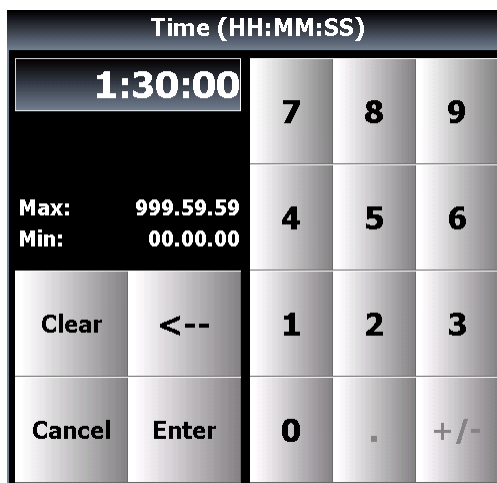

Figure 4-2 Step Time Entry

Since one hour and thirty minutes is also a time of 90 minutes, you can also enter a value of 9000 for 90 minutes, 00 seconds. Upon pressing the 'Enter' button, the time will be formatted and displayed in the step data list view as 1:30:00.

! *A step time of zero can be entered for a step to implement an immediate set point change. This will cause the chamber to go to the set point as quickly as possible. When used in conjunction with a "wait" condition on the following step, there is no need to know the time it takes for the chamber to achieve set point.*

The wait can be used to trigger the next step, typically a soak, so that the desired soak time is achieved without having to determine what additional time may be needed in order to make sure the chamber reaches set point before starting the soak time.

4.1.2 Entering Step Set Points

The length of time, loop set points and jump conditions for each step are entered by touching the corresponding row for the desired entry in the list on the left side of the Program Entry screen. To enter set points for each control loop, touch the loop in the step data list view and enter the desired set point via the numeric keypad.

The loop set points are used as the target set points for the step, i.e., the set point that each control loop will reach by the end of the step. Each set point will then change independently of the other set points in order to arrive at the target set point when the time left in the step reaches zero. Thus, based on the time entered and the difference in set point from the previous step, the step will either be a 'ramp' step or a 'soak' step.

Entering a Soak Step

The set point entry for a step defines the target set point, i.e., the set point that will be achieved by the end of the step. Thus, if the set point of the step matches the set point for the control loop from the previous step, the loop will soak, i.e., remain at that set point for the entire step creating a soak step.

When adding (inserting) steps into the program, the new step assumes the same set points and events as the current step. Thus, as steps are added, the new step is automatically a soak step. By simply adjusting the time of the new step, soak step entry would be complete.

Entering a Ramp Step

A ramp step is merely a step with a set point that is different from the previous step. The loop's set point will then ramp from the previous set point, to the set point of the current step, linearly over the time entered for the step. This creates a ramp step.

When adding (inserting) steps into the program, the new step assumes the same set points and events as the current step. Thus, as steps are added, the new step is automatically a soak step. By simply changing the set point for a loop, the step becomes a ramp step. Adjusting the time length of the step will then vary the ramp rate.

4.1.2.1 Entering Ramp Rate

In order to enter a ramp rate, you can either calculate the time it will take to go from the previous step's set point to the current step's set point at the desired ramp rate and enter the time for the step directly, or you can enter the ramp rate on the numeric keypad when entering the loop set point.

For example, if you desire a ramp rate of 0.5 degrees per minute from the previous step's 24 degree set point to the new 85 degree set point, the step time will be the difference in temperature (61 degrees) divided by the rate of 0.5 degrees per minute. This equates to a time period of 122 minutes (2 hours and 2 minutes). Thus, the step would require a set point entry of 85 degrees and a time entry of 2 hours, 2 minutes.

Or, when entering the loop set point for the ramp step of 85 degrees, you could specify a ramp rate by touching the ramp rate field on the numeric keypad and then enter the desired ramp rate of 0.5 degrees.

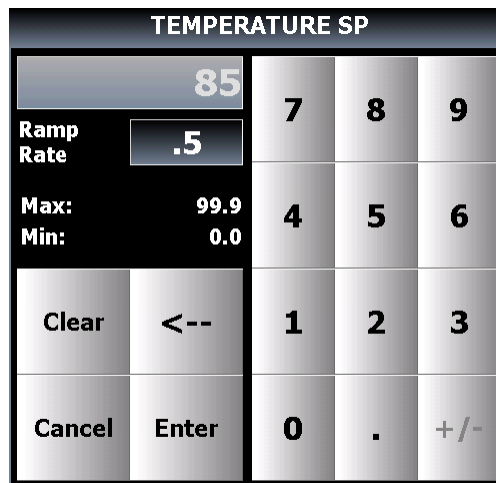
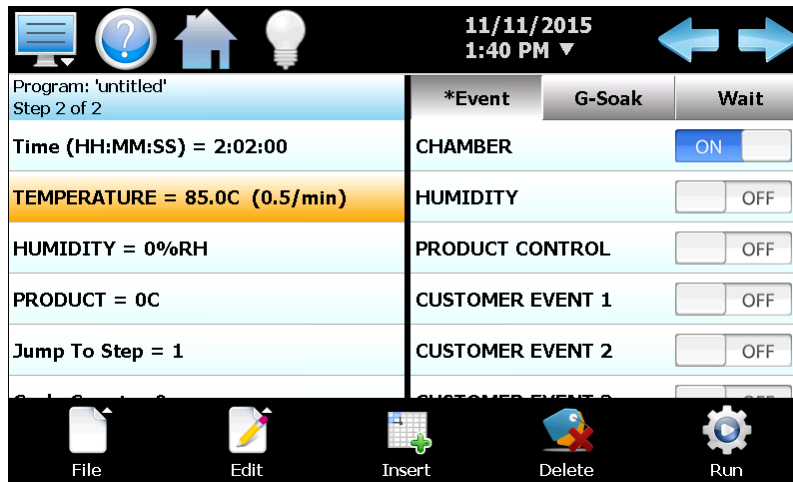

Figure 4-3 Set Point (Ramp Rate) Entry

Once the "Enter" button is pressed, the time length of the step will be automatically calculated in order to achieve the desired ramp rate and will be shown in the step data list view along with the set point and the specified ramp rate.



The ramp rate entry is fixed in units/minute with a range of 0.0 to 99.9. When the ramp rate entry is zero (or left blank), the EZT-570S simply enters the new set point.

- ! Ramp rate can only be entered on one loop per step since the program operates on a single time base. In order to set the ramp rate (and subsequent time length for the step) to a different loop, you must clear an existing ramp rate entry.

Entering step time will clear any existing ramp rate entry on the step. Ramp rate is a function of time and difference in set point, so the length of time for the step can be entered or a ramp rate can be entered, not both.

When entering ramp rate, on temperature for example, it sets a length of time for the step based on the ramp rate and set point entered. If another set point is different from the previous step, humidity for example, the humidity set point will also ramp to the humidity set point for the step. However, the actual ramp rate for humidity will be based on the difference in set point from the previous step and the time length of the step. It will not be equal to the ramp rate for temperature.

4.1.3 Setting Step Events

The **Event** selections are used to select which system events are to be on during the step. To edit step events, press the 'Event' button on the Program Entry screen. This will display the list of all chamber and customer events. You can then select which events are to be on during the step by touching each event on/off button to toggle the events on or off.

- ! The step events must be set individually for each step. Also, for the chamber to operate, the relevant chamber systems must be turned on via event selection. Even though a ramp/soak program may be in operation, if the events are not set, the chamber will not run.

To help reduce the number of actions required to create a program, each time a new step is added, the events of the current step will be automatically copied to the new step eliminating the need to set them. Most programs require the same events to be set one each step, thus eliminating the need to set them manually. If an event is not required on the new step, then only the one event would need to be turned off.

The EZT-570S also provides the “Same Events” function from the “Edit” menu button. When selected, all event selections of the current step will be copied to all following steps. This can be useful when making copies of programs. For example, if you wish to create a temperature only program from an existing temperature/humidity program, you can save the temperature/humidity program under a different name. On step 1 of the program, turn off the humidity event, and then use the “Same Events” function to copy the events from step 1 to all following steps. This would turn off humidity on all steps without the need to go through each step individually to turn off the humidity event.

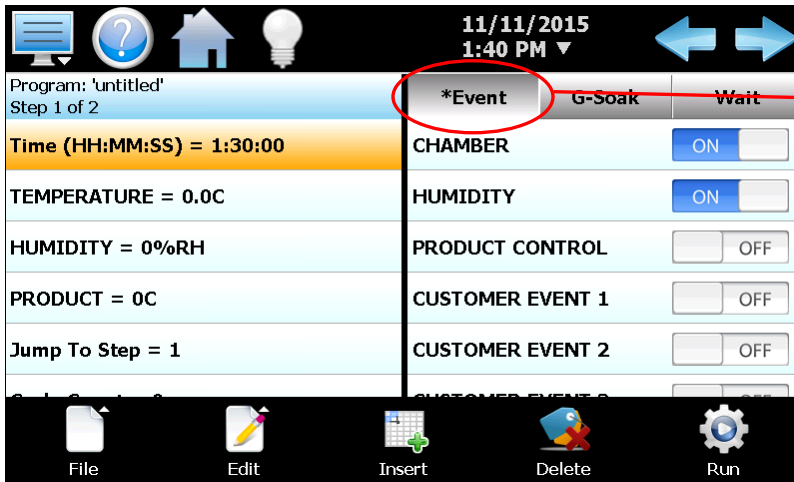

Figure 4-4 Program Step Events

When at least one event is turned on in a step, an asterisk '*' will appear before the word 'Event' on the list selection button.

This lets the user know that events have been turned on without having to press the 'Event' button, or if the events that are on are not currently shown in the list due to the scroll position of the list.

4.1.4 Setting Guaranteed Soak Events

The **G-Soak** selections are used to turn on the guaranteed soak option for one or more of the control loops. To enable guaranteed soak for a loop, first press the 'G-Soak' button above the event list view on the Program Entry screen. This will display the list of soak selections for each loop of the chamber.



Figure 4-5 Program Soak Events

When a guaranteed soak selection is made on a step, an asterisk '*' will appear before the word 'G-Soak' on the list selection button.

This lets the user know that guaranteed soak selections are made without having to press the 'G-Soak' button.

Press the on/off button for a loop to toggle the guaranteed soak selection on and off as desired. When the guaranteed soak event for a loop is turned on, the program will automatically enter a hold condition during the step if the loop's PV deviates from its set point by more than the soak limit setting for the loop as entered on the G-Soak Limits screen.

! *Guaranteed soak should not be used on ramping steps. The ramp rate will be affected if the process variable deviates from the soak band because the program will be placed in hold. When the program is in hold, the step length will be extended and the set points will no longer ramp at the desired rate. Guaranteed soak should be used on soak steps to make sure that the process stays at the desired set point, within the soak band, for the entire duration of the step.*

4.1.5 Using Wait For

The “wait” function is a powerful tool for pausing a program until a particular process variable reaches a predefined set point. This differs from the guaranteed soak function by being a single shot monitor. With the guaranteed soak, the process variable is monitored throughout the whole step. If the process exceeds the upper or lower soak band, the program will pause until the process returns to within the band. The wait for function puts the program in hold and “waits for” the process to exceed a particular value that is set for the step. Once the process reaches this set point value, the program will resume.

A program can also be set to wait for a digital input. This allows any of the eight optional digital inputs to be selected. When the EZT-570S reaches the step, it will wait for the input to change state before continuing the step.

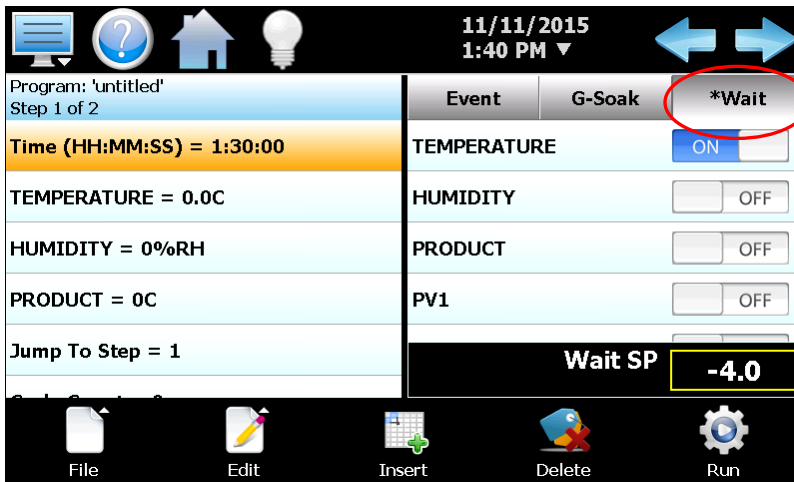

When a wait selection is made on a step, an asterisk '*' will appear before the word 'Wait' on the list selection button.

This lets the user know that a wait for condition is entered for the step without having to press the 'Wait' button.

Figure 4-6 Program Wait For

To enable a wait condition in a step, first press the 'Wait' button above the event list view on the Program Entry screen. This will display the list of available wait selections. Select the input to wait for, and if a process variable is selected (Loop or monitor input) enter the set point for the wait. This is the set point that the process variable must reach in order for the step to continue.

! *The set point entry for a wait step is critical for the “wait for” loop or monitor to operate correctly. During the wait state, the selected process input must arrive at or cross the set point (Wait SP) in order for the program to resume operation.*

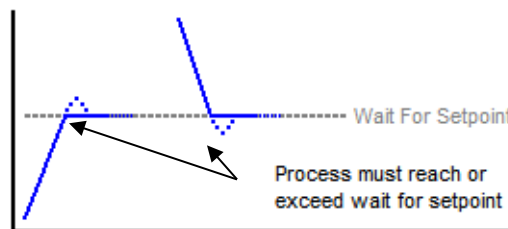

The monitor input and digital input selections are only available if the option is available on your chamber. When using a digital input as a wait for selection, the digital input must be configured as a “wait input”. If it is not configured as a “wait input”, the program will ignore the wait for selection and continue through the step. See section 8.6.3 Digital Inputs for more information.

4.1.6 Using Jumps

The jump allows the program to “jump” between different steps within it. This is useful for repeating the same ramp/soak combination during extended cycle testing of product. When a jump is programmed on a step, the program will first execute the step as a normal step; however, once the step time is complete, the program will jump to the specified “jump to step” rather than continuing on to the next step in the program. After all of the programmed jumps have been completed, the program will then continue to the next sequential step in the program without making any further jumps.

To program a jump, enter the step number that you want the program to jump to when the step is complete, along with the total number of jumps to be made. A cycle count of zero on a step indicates that no jump will be made once the step is complete regardless of what the jump step number is set to.

Jump to Step: Sets the step number that the program will jump to upon the completion of the step. The program will only jump to this step if the cycle count is greater than zero.

Cycle Count: Sets the number of jumps that will be made from the step. Once all jumps have been made, the program will continue on to the next step in sequential order.

! The cycle count defines how many jumps will be made. Thus, if you wish to perform 10 cycles within a program, your cycle count will be set to 9, 10 minus the 1 performed prior to reaching the jump step.

Example:

Product is to be loaded into the test chamber at ambient conditions, cycled between +85 and -40 for 10 cycles, and then returned to ambient temperature, so that it can be removed in order to load the next test sample.

- Step 1 Start at +25
- Step 2 Ramp to +85
- Step 3 Soak at +85
- Step 4 Ramp to -40
- Step 5 Soak at -40
Set Jump to Step=2
Set Cycle Count=9
- Step 6 End at +25

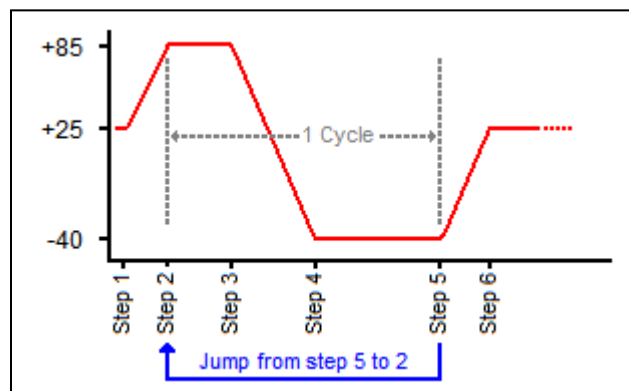

With the jump programmed on step 5, the program will jump from step 5 back to step 2 after the soak time has completed. The program will then repeat steps 2 through 5. It will continue to do this until all 9 jumps have occurred. Once all 9 jumps have been completed, the program will continue on to step 6 after the final soak at -40. Since 1 cycle is made prior to the first jump at the end of step 5, a total of 10 cycles are completed.

4.1.7 AutoStart

Auto start is a feature that can be used to start a ramp/soak program on a specified date or day, and time (of a 24-hour-clock). The settings are saved with the program. To enter settings for program auto start, first select “AutoStart” from the Edit menu button on the Program Entry screen. Choose the desired auto start method, by date or by day, from the drop-down menu and enter the start time settings.

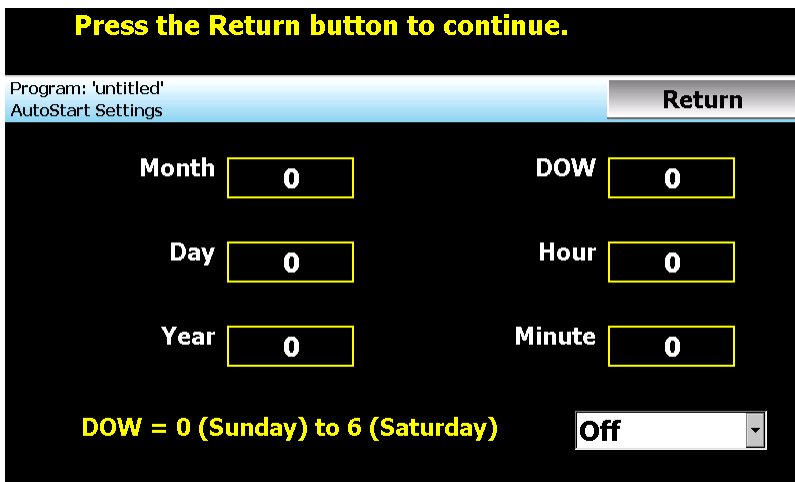

Figure 4-7 Program AutoStart

When auto start by date is selected, the exact date and time must be entered. Enter the month, day, year and time of day in hours and minutes for when the program is to start. The day of week is not required to be set. It is not used for this function. When auto start by day is selected, only the day of week and time is required to be entered. The date settings are ignored. The EZT-570S simply looks for the day of week and time to begin the program.

! *The time is entered in a 24-hour time format. To convert time from a 12-hour format (AM/PM) into 24-hour format, add 12 to the hours for PM time. For example, 2pm will be a value of 14 (2 + 12) for hours. A time of 5:30pm will be 17 hours, 30 minutes.*

Once all entries have been made, press the “Return” button to get back to the Program Entry screen.

4.1.8 Guaranteed Soak Limits

To access the guaranteed soak limits, select “G-Soak Limits” from the Edit menu button on the Program Entry screen. The Guaranteed Soak Limits screen is used to set the control tolerance for guaranteed soak steps when in program operation. When the process variables deviate from their set points by more than the soak limits, the program time will stop until the process variables re-enter the soak bands. These limits apply to each step in the program and only need to be set once.

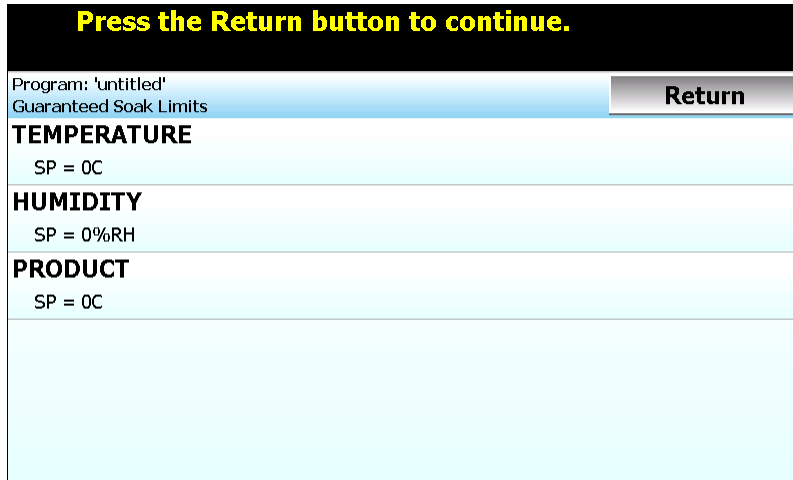

Figure 4-8 Guaranteed Soak Limits

To change a limit, touch the desired loop in the list, enter the new limit setting on the numeric keypad and press 'Enter' when finished. The new limit value will then be shown in the list view for the selected control loop. Once all entries have been made, press the "Return" button to get back to the Program Entry screen.

! *If soak limit is set too tight, i.e., a very small deviation value from set point, it could prevent the program from operating as desired because the process may not be able to be controlled to such a tight limit setting.*

4.2 Program Plot

The program under edit can be viewed graphically by "Plot" from the Program menu. This allows you to see if the program entered matches the expected appearance. The Y-axis auto-scales to fit the range of set points entered for each loop in the program. The X-axis auto-scales to the total time duration of the program. Note that jump steps are not shown on the plot.

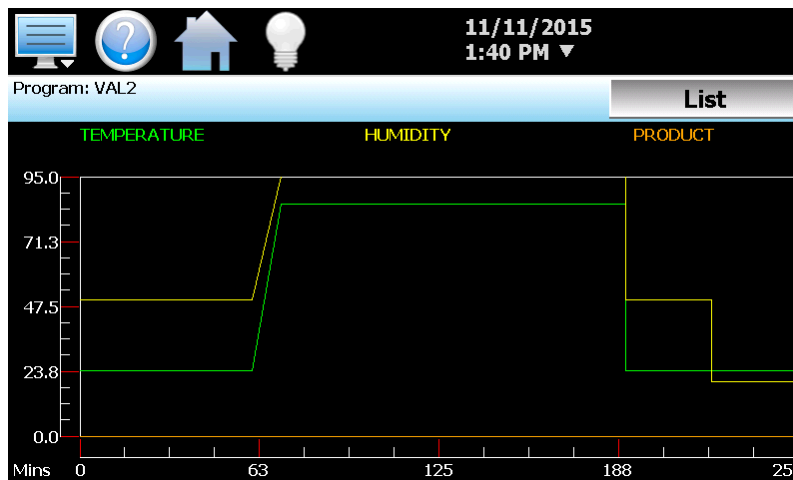

Figure 4-9 Program Plot

4.2.1 Program List

The program Plot screen also provides the user with the option to view all program steps in a scrollable list format by pressing the "List" button. To revert back to the plot view, press the "Plot" button.

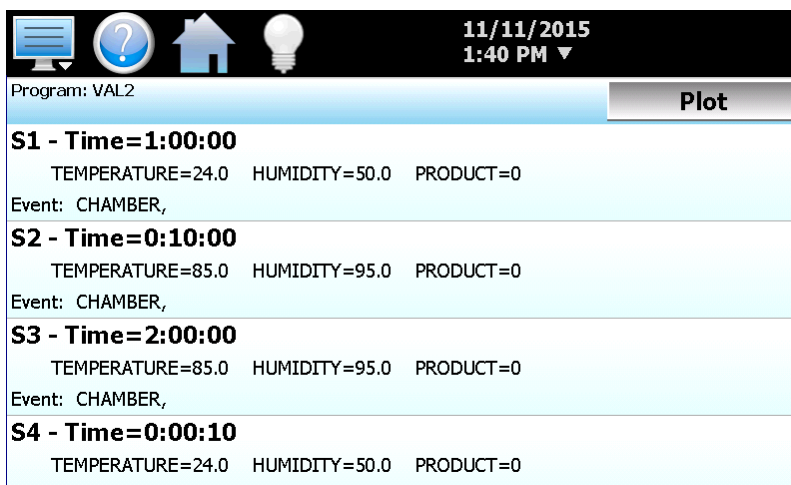

Figure 4-10 Program List

The list will display each step of the program including time, jump entry, loop set points and programmed events. If a wait condition is programmed for a loop, the set point of the loop will be followed by a "(W)". If guaranteed soak is programmed for a loop, the set point will be followed by a "(GS)". Note that a wait condition for a digital input is not shown on the list view.

4.3 Starting an Automatic Ramp/Soak Program

The selection, starting and stopping of ramp/soak programs is done via the Program Operation window. This can be accessed from the Main loop view and Overview screens by pressing the "Program Operation" button and on the Program Entry and Status screens by pressing the "Run" button icon.

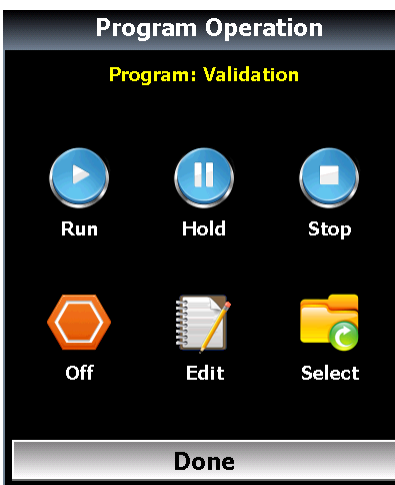

Figure 4-11 Program Operation

The Program Operation window provides selections for program run, hold, stop, and off as well as short cuts for accessing the Program Entry screen via "Edit" and selecting which program to run from available programs stored on the EZT-570S via "Select". The status of the current program is displayed at the top of the window. If a program is not in operation, the current name of the program selected to run will be shown.

In order to start a ramp/soak program, it must first be loaded into the EZT-570S control module. This is done automatically upon new program selection, or when running the program under edit from the Program Entry screen. When the “Run” button is pressed, you will be prompted to select the step for the program to start on (default is always 1). If you wish to start the program on a different step, press the start step field and enter the desired start step via the numeric keypad or use the left and right scroll buttons to adjust the step number.



Figure 4-12 Program Start Step

Once the desired start step number is entered, press the “Start” button. The program will then be transferred to the control module’s memory and then started once the transfer is complete. The Program Operation screen will then be automatically closed.

! *If the program was set up with the auto start feature enabled, the program will enter the auto start mode immediately upon start. Once the set date or day and time are reached, the program will begin running. The start date shown on the Program Status screen indicates when the program will start based on the auto start settings.*

If you run the current program that is already loaded, you will not be prompted to select the start step. The program will automatically be started from step 1. This provides simple start/stop operation when repeating the same program for multiple tests. If you wish to start the program on a different step, first select the program by pressing the “Select” button and choosing the program from the list of available programs. Then press the “Run” button. You will then be prompted to enter the start step prior to the program being reloaded and run.

To stop a program, select “Stop” or “Off” from the Program Operation window. When a program is stopped, the loops will return to single set point (static mode) operation.

The **Stop** selection stops the running program, but leaves the set points and events at their current values when the program stops. This allows you to stop a program and continue running the chamber in manual mode.

The **Off** selection stops the running program and turns all events off. The set points will remain at their current values when the program is stopped; however, all events will be turned off. This allows you to immediately stop a program and shut down the chamber with a single selection.

4.3.1 Hold/Resume Ramp/Soak Program Operation

At any time during the operation of a program, it can be manually placed into hold. This stops the program timer; however, the chamber continues operation under the current step settings at the time the program was put into hold. To pause the running program, select “Hold” from the Program Operation window. To resume the program from the point in which it paused, select “Run”.

! *When a program is in hold, the set points and events can be manually changed; however, once program operation is resumed, the set points and event status will return to those defined by the program step.*

4.4 Monitoring Automated Ramp/Soak Program Operation

The Program Status view provides all status information regarding the operation of the current program. It can be accessed directly from the home Program menu.

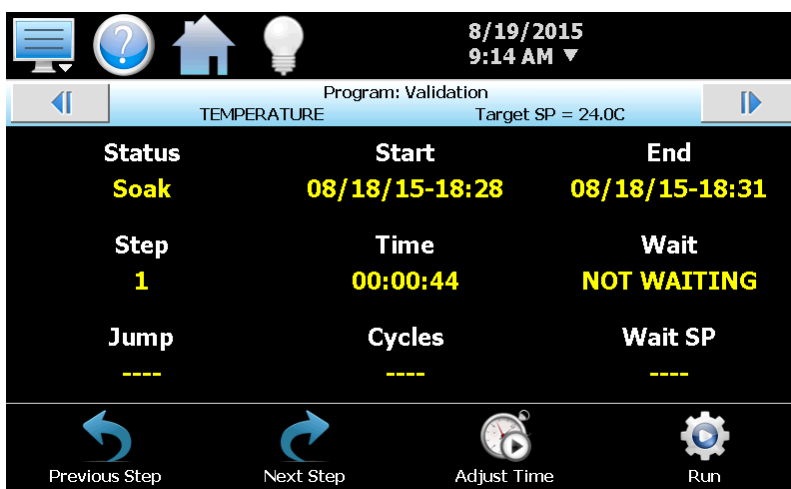

Figure 4-13 Program Status

Status indicates the current program operating mode, i.e., active, hold, ramp, soak, waiting, etc.

Start indicates the date and time at which the program was started.

End is the calculated stop date and time for the program.

Step indicates the step number currently being executed.

Time is the time remaining in the current step.

Wait indicates the input(s) being monitored if a wait for condition is present.

Wait SP shows the set point or digital input number for the wait for condition if active.

Jump indicates the step number that program will jump to at the completion of the current step.

Cycles indicates the number of jumps remaining for the step (if any).

The **loop set points** for the current step can be viewed at the top of the screen by pressing the left and right scroll buttons to cycle through each loop. Note that the set points shown here are the target set points, not the actual set points the loops are controlling to. To view the actual control set point, see the Main loop view or Overview screen.

4.4.1 Advance Previous/Next Step

The advance step functions allow you to skip certain program steps or repeat them by advancing to the desired step. To advance to a previous or next step in the program, it must first be put into hold. Once the program is in hold, the advance step buttons on the Program Status screen will be enabled.

By selecting “Previous Step” or “Next Step”, the program will jump back or jump forward by one step each time the menu item is selected. When the program is on the desired step, place it back into run and the program will resume operation from the beginning of the step.

4.4.2 Adjusting Step Time

During program operation, the length of time remaining in a step can be adjusted to increase or decrease the time left. The adjust step time function allows you to add or subtract time from the current step; however, the program must first be put into hold. Once in hold, the “Adjust Time” button on the program Status screen is enabled.

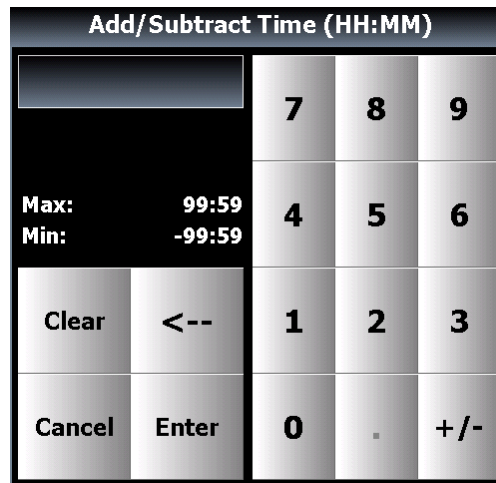

Figure 4-14 Adjust Step Time

When selected, the numeric keypad will be shown. Enter the time adjustment in hours and minutes and press ‘Enter’ when finished. The time remaining in the step will be adjusted by the total time entered. Once complete, resume the program.

- ! *When adjusting the time of a ramping step, the ramp rate will be altered for the remainder of the step. The ramp rate will decrease if time is added and increase if time is removed. To subtract time from a step, enter a negative value for hours and minutes.*

4.5 Program Worksheet

This table can be used as a template for creating programs prior to entering them on the EZT-570S. It can also be used as a tool for quick checks to make sure all of the entries were made correctly.

Profile Name: _____
 Date Programmed: _____
 Programmed By: _____

Step #										
Set point	1									
	2									
	3									
	4									
	5									
Step Time (H:M:S)										
Chamber	1									
Events	2									
	3									
	4									
	5									
	6									
	7									
	8									
	9									
	10									
	11									
	12									
	13									
	14									
	15									
Customer	1									
Events	2									
	3									
	4									
	5									
	6									
	7									
	8									
	9									
	10									
	12									
	12									
	13									
	14									
	15									
GS	1									
Events	2									
	3									
	4									
	5									
Wait for										
Wait for Set point										
Jump Step										
Jump Count										

4.6 Frequently Asked Questions About Ramp/Soak Program Operation

1. How do I start or run a ramp/soak program?

From the Main loop view or Overview screen press the “Program Operation” button or on the Program Status or Program Entry screen press the “Run” button icon. Press the “Run” button on the Program Operation window, or press the “Select” button to select from a list of programs stored in the EZT-570S memory. Select the desired program from the list, and then run the program.

2. How do I know which program is running?

When a program is running, the name is displayed on Program Status view screen as well as the Main loop view and Overview screens. The EZT-570S will indicate that the program is running when it is in operation. If a program is not running, the EZT-570S will display the name of the currently loaded program, i.e., present in memory and ready to be run.

3. Why does the program not ramp to the set points in the first step?

The program operation of the EZT-570S was designed to operate the chamber based on the set points and events defined in the program. Since the chamber can be at random set points when a program is started, this could cause the chamber to not follow the selected program properly or the same each time it is run. To ensure that the program is executed in the same manner each time, the chamber set points are immediately set to the first step’s set points for the length of the step. This acts as an “initialization” step to get the chamber running and conditioning product as desired prior to performing ramping sequences of the program. This eliminates the need for the operator to set the chamber to the proper set points prior to starting a program.



For instances where only a single ramp is required, or a remote software package is being used to send ramping sequences to the EZT-570S, the program operation was designed to except a one step program. If a one step program is run, the chamber will ramp from its current set points to the set points of the one step program. It will not immediately take the set points of the step. Thus, by executing one step programs, ramping sequences can be executed when required and not on predefined time intervals. This is especially useful and simplifies programming when custom software applications are being used to control the chamber.

4. How do I enter a jump step?

A “jump step” is a normal step; however, instead of continuing to the next step of the program when the step is complete, the program “jumps” to a specified step. To enter a jump, set the step number you want to the program to jump to, and the number of times that the jump is to take place, into the step you want to jump from. When that step is complete, the jump settings will tell the program to jump to the specified step until all jumps have taken place. The next time the jump step is executed (after all jumps have taken place), the program will continue on to the next step.

5. Why is the program not coming out of Hold?

If an alarm condition is present which shuts the chamber down, the program is automatically placed into hold. The alarm condition must be cleared in order for the program to resume operation.

6. Why is the program not coming out of a Wait?

When a “wait for” condition is applied to a step, the step will not begin until the wait for condition is met. If the wait for condition is an input to the EZT-570S, the input must reach and/or exceed the wait for set point. If the input does not reach the set point, the step will not continue.

When using a wait for to initiate a soak time, be sure to place the wait for condition on the soak step. If the wait condition is applied to the ramp step, the program will not continue because the set point will not change until the wait for condition is met, i.e., the ramp cannot take place until the step is executed. Since the set point does not change, the input will not change to meet the wait for set point and the program will wait indefinitely.

If the wait for condition is a digital input, the selected input must meet its configured transition state after the wait for has been initiated. If the input turns on or off before the wait condition has been initiated, the program will not continue because the change in state of the input must be seen after the wait step has been entered.

7. Why does my program not start immediately when “run” is selected?

When a program is started, the EZT-570S scans the program and calculates the overall run time in order to provide an estimated date of completion. Depending upon the total number of steps in the program (including the number of jump steps used), it may take the EZT-570S a minute to process all of the steps in order to calculate this time. Programs can easily reach into the 1000’s of steps when multiple jumps are used, and it takes time to process through all of the step data.

8. Why has the program not completed its run by the stop date given when I started it?

The estimated stop date provided by the EZT-570S for the program is a calculated value based on the sum total of all step times. This time can be affected by any guaranteed soaks or wait for conditions entered into steps of the program. The effects of these times are an unknown and can cause the program to run longer than calculated because they pause the program until their conditions are met.

The EZT-570S does update the estimated stop date based on these conditions as they occur; however, it does make the stop date a moving target.

9. I have guaranteed soak turned on, why is the chamber not following the ramp step?

Guaranteed soak should not be turned on for ramping steps. Guaranteed soak is used to pause a step until the selected input is within the soak band around set point. On a ramping step, if the step time is paused due to an input leaving the soak band, the ramp rate is then affected because the set point is no longer changing. It will hold at that set point until the input returns to the soak band.

Since the purpose of a ramping step is to change the set point over time, the input could be constantly falling in and out of the soak band throughout the step, thus causing the program to start and stop. This will elongate the overall step time and alter the rate of change of the set point. Guaranteed soak should only be enabled on soak steps.

5. System Settings

This section covers the use of extended controller features that enhance the functionality of your chamber. To gain access to the setup options, select “Settings” from the Device menu.

5.1 Recovery

The power recovery settings direct the EZT-570S’s response to the interruption of electrical power. The EZT-570S’s battery-powered real-time clock tracks the amount of time the power is out. When power is restored, the controller compares this amount of time to the Power-Out Time setting and takes whatever action is selected in the Recovery State.

First, determine how long the power can be interrupted without adversely affecting results. Set the Power-Out Time to this time. If power is returned in less time than this setting, the chamber will automatically continue operation where it left off. If it takes longer than the recovery time setting for power to be restored, it will take action based on the Recovery State selection.

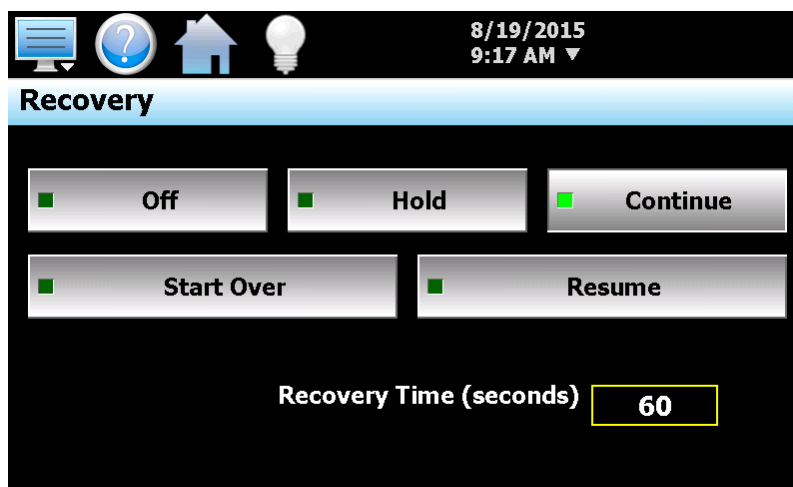

Figure 5-1 Power Recovery

- Off** Select “Off” to have the chamber default to the off state on power-up. If a ramp/soak program was active prior to the power outage, the program will also be stopped.

- Hold** Select “Hold” to have the chamber return to operation at the same point it was prior to the power outage. If a ramp/soak program was running, the program will still be active; however, it will remain in hold until manually set to continue.

- Continue** Select “Continue” to have the chamber pick-up where it left off on loss of power. If a ramp/soak program was running prior to the power outage, it will resume where it left off and continue through the rest of the program when power is restored.

- Start Over** Select “Start Over” to automatically restart the ramp/soak program that was running at power failure. Use this option if it is critical for a program to run from start to finish without interruption.

- Resume** Select “Resume” to have the chamber pick-up where it would be at the current time, if power had not been lost. If a ramp/soak program was running prior to the power outage, the EZT-570S will advance forward through the program to the point where it would be, at the current time, and resume operation from that point.

5.2 Set Point Limits

The Limits screen allows for the adjustment of the minimum and maximum operating set points allowed to be entered for the control loops. These limits can be used to prevent operators from entering a value that exceeds the survivability limits of a product being tested, reducing the risk of product damage.

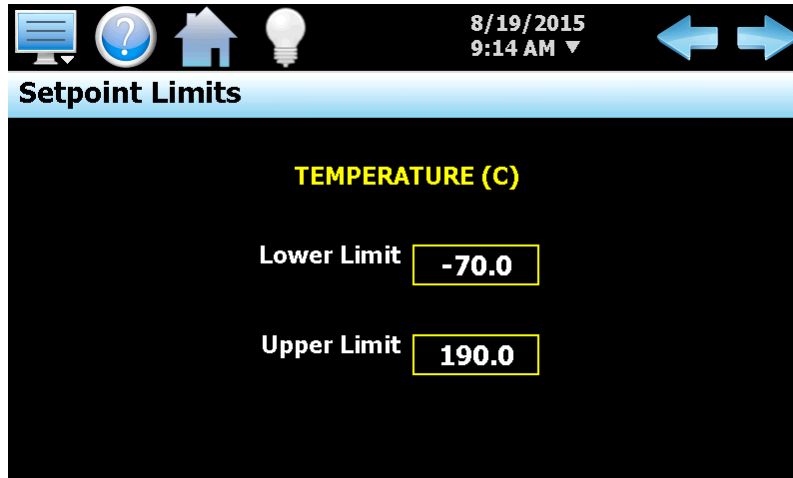

Figure 5-2 Set Point Limits



The set point limits are factory set for the maximum safe operating range of the chamber. These limits are locked out from user adjustment by default at the factory. User adjustment of these limits, which exceed those limits set by the factory, may result in damage to system components and will void the chamber warranty.

5.3 Event Names

The names of the optional customer events can be changed to describe what function they are used to perform. To alter event names, select “Event Names” from the Setup menu.

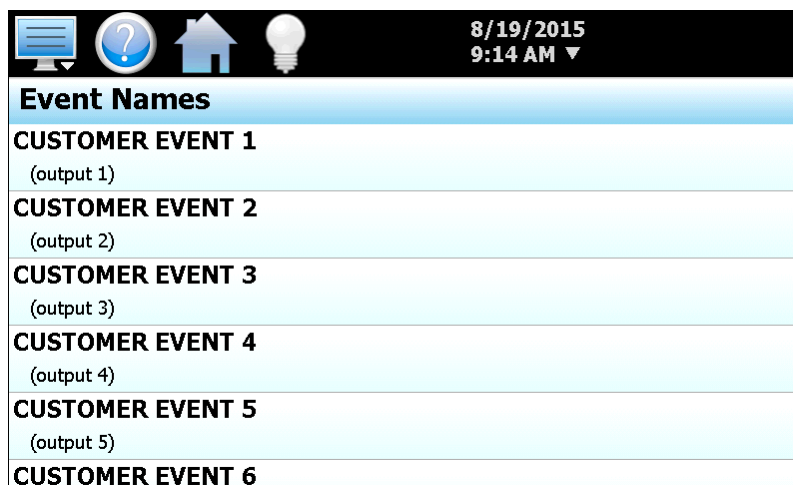

Figure 5-3 Event Names

To change the name of the event, select the event by touching it in the list view. A text entry keypad will be shown allowing you to enter a new description (up to 16 characters long). Once complete, press “Enter” and the new name will be shown in the list and used throughout all EZT-570S screens.

! The default names for the optional events are “Customer Event 1” to “Customer Event 15”. These will be shown in all events lists even if the optional digital outputs are not present. If you do not want to see the customer events in manual operation or program step event lists, you can remove them by changing the name of the event to a single dash “-”. This removes the event name from all list views.

Any customer event or combination of events can be hidden and removed from event list selections by setting the first character of the event name to a dash. This allows outputs that are configured for use other than a customer event output such as program running or chamber alarm, to be hidden so as not to confuse an operator by providing event selections for outputs that are configured for other functions than an event output.

5.4 Alarms

The EZT-570S provides user configurable alarms for each input. The alarms are activated when the process value leaves the selected range. A user can configure how and when an alarm is triggered, what action it takes and whether it clears automatically when the alarm condition is over or requires manual reset.

! For chambers equipped with a product loop, the product alarm is fixed to an absolute high/low alarm with the silent and shutdown modes fixed to silent off and shutdown on. This is done to ensure that a basic level of precaution is taken to minimize the risk of damage to the device under test. However, it is still the responsibility of the end user to make sure that the alarm set points are within safe limits for the test device.

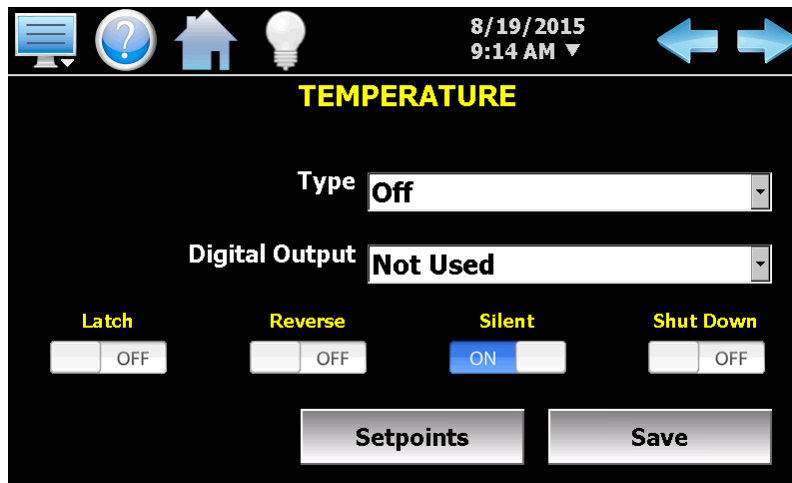

Figure 5-4 Alarm Settings

Alarm Type

Absolute: An absolute alarm uses one or two set points to define an alarm condition. An absolute alarm can be set for high only, low only or both (high and low).

Deviation: A deviation alarm uses one or two set points that are defined relative to the control set point. High and low alarm set points are calculated by adding and/or subtracting offset values from the control set point. If the set point changes, the window defined by the alarm set points automatically changes with it. A deviation alarm can be set for high only, low only or both (high and low).



The deviation alarm type is not available for the optional monitor inputs. The monitor inputs are not associated with a control set point.

Alarm Modes

Latch: An alarm with the latch turned on will remain active after the alarm condition has passed. It can only be deactivated by the user by pressing the Reset button on the Alarm screen. An alarm that has latching turned off will be self-clearing and will deactivate automatically when the alarm condition has passed.

Reverse: When reverse action is turned on, the digital (customer event) output assigned to the alarm will be energized in a non-alarm condition, i.e., fail-safe. When reverse action is turned off, the output is normally open and will close in an alarm condition.

Silent: This is used to control the method by which an alarm is reported. When silent mode is turned off, an alarm condition will trigger the audible alarm on the chamber and the alarm icon will flash to indicate the alarm condition. The audible alert must then be manually silenced by pressing the reset button on the alarm monitor screen.

If silent mode is turned on, there will be no audible alert when an alarm condition is present. In addition, if the alarm is not set to latch, the alarm icon will not be shown. The alarm will be reported on the alarm screen, but no visual alert will be given. If the alarm is set to latching and/or to shut down the chamber, the alarm icon will be shown in order to provide a visual alert to the operator that user intervention is required.

Shut Down: If shut down is turned off, the alarm will not affect the operation of the chamber. If shut down is turned on, the chamber will turn off all systems in an alarm condition. If an automatic ramp/soak program is operating, the program will also go into hold.

Digital Output Assignment

If the EZT-570S is equipped with the customer event option, the alarm can be assigned to one of the event outputs. When the alarm activates, the output will work in conjunction with the alarm and turn on when the alarm is active and off when the alarm is cleared.



The event output must be configured to be used as an alarm output. If the alarm output selected is not configured to be an alarm output, it will not function according to the alarm settings. See Section 8.6.4 Digital Outputs, for information on how to configure the operational mode of the customer event outputs.

5.4.1 Set Points and Alarm Message

The alarm set points and alarm message are accessed by pressing the “Setpoints” button at the bottom of the Alarm screen.

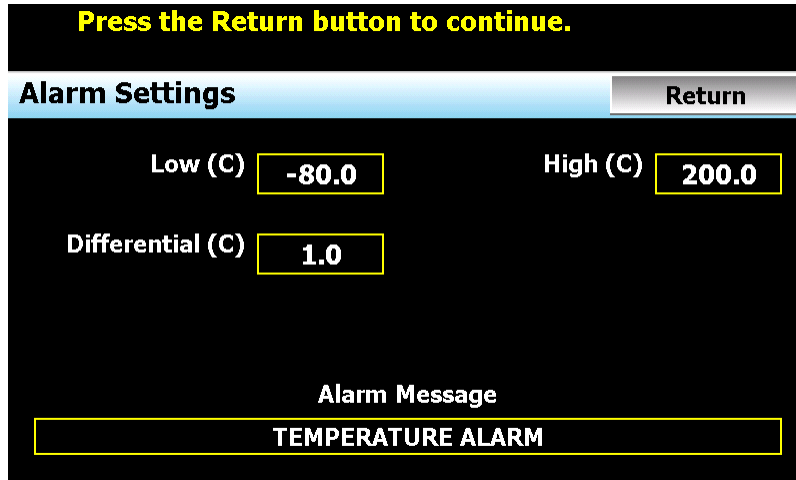

Figure 5-5 Alarm Set Points and Message

! The low and high alarm set point fields are shown for all alarm types; however, only the high set point is used for 'high' alarms, low for all 'low' alarms and both fields are used for Absolute and Deviation 'both' alarm types.

Alarm Set Points

High: The alarm high set point defines the process value that will trigger a high side alarm. It must be higher than the alarm low set point.

Low: The alarm low set point defines the process value that will trigger a low side alarm. It must be lower than the alarm high set point.

Differential: The differential (often referred to as alarm hysteresis or dead band) defines how far the process must return into the normal operating range before the alarm can be cleared.

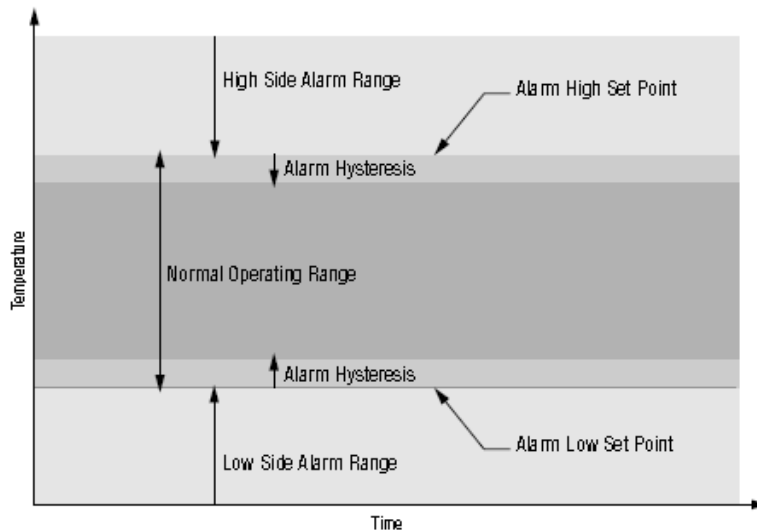

The **Alarm Message** is the text notification that appears on the Alarm screen when the alarm activates. This message can be edited (up to 24 characters maximum) so that the alarm message more accurately describes what the alarm means.

5.5 Product Control

If the chamber is equipped with a product control loop, this screen will be accessible from the device settings View menu.

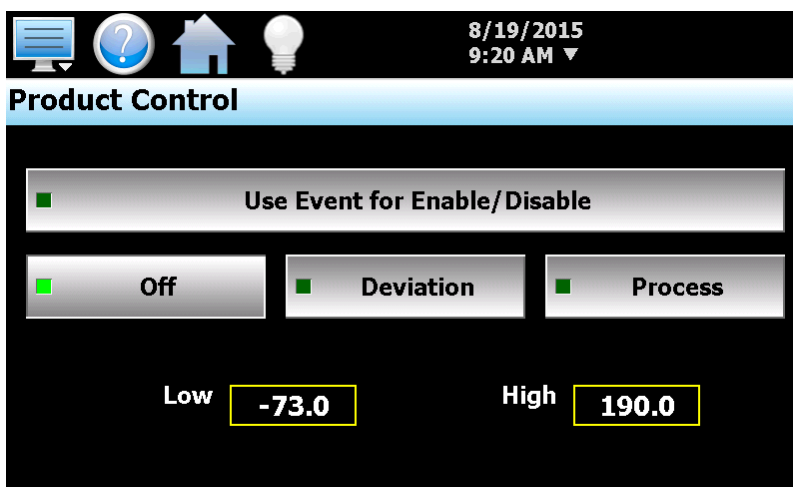

Figure 5-6 Product Control

Product control is a control strategy in which one control loop provides the set point for another loop. It allows the process or part temperature to be reached as quickly as possible while minimizing overshoot. Product control can be used to optimize the performance of chambers containing product with long thermal lag times.

If only single-loop control is used, air temperature for example, the air will reach its designated set point and the chamber will hold at this temperature. However, the part in the chamber may take hours or even days to reach this temperature due to its thermal mass. The reason for this is the fact that as the part temperature approaches the air temperature, the difference between the part temperature and the air temperature decreases. This difference in temperature is what forces the heat to move between the part and the air. The lower this difference, the slower the heat moves. The composition of the product material, whether it is a natural insulator or conductor, also affects this rate of heat transfer.

The product control feature can be used to speed up this process and ensure that your part reaches the desired temperature as quickly as possible. It does this by monitoring the part temperature through the product control loop, and based on the set point for product temperature, generates a set point for the air temperature control loop. This set point is then automatically fed into the air temperature control loop. This allows the air to exceed the desired product temperature and increase the temperature difference between the part and the air. This accelerates the transfer of heat between the air and product under test.

There are two modes of operation for the product control feature, deviation and process. These modes define how the air temperature set point is calculated.

Deviation: This mode uses the lower and upper set points to generate a set point that is defined relative to the product set point. The upper and lower range of the air temperature set point is calculated by adding and/or subtracting these values as offsets from the product set point. As the product set point changes, the window defined by the upper and lower points automatically changes with it.

Process: This mode uses the lower and upper set points as the upper and lower range of the air temperature set point. The output of the product control loop is then used to calculate a linear set point between these two values in order to provide the set point for the air temperature loop.

The deviation mode has the benefit of limiting the maximum and minimum temperature that the air can achieve relative to the desired product set point. This allows the system to be fine-tuned to the minimum amount of overshoot required to obtain the desired product temperature.

The process mode has the benefit of maximum change rates by allowing the air temperature to go to absolute limits. This allows the product to achieve set point temperature as quickly as possible, but does so at the cost of stability. If the part has a large thermal lag, the air temperature control may oscillate uncontrollably once the product reaches set point because of the large overshoot. In most cases, deviation control is the recommended selection.

The product control feature can be turned on and off in one of two ways. It can be either enabled or disabled by pressing the desired mode control button, disable, deviation or process, or an event can be used to enable and disable the selected mode when the “uses event” button is chosen in addition to the product control mode.

Uses Event: When this selection is made, the selected product control mode (deviation or process) is turned on and off with the product control event (chamber event 10). When the selection is not made, the selected product control mode is in operation at all times until disabled by the user.



The uses event selection for enable/disable allows product control to be turned on and off during different steps of a ramp/soak program or manually from the Overview screen or Manual Operation window on the Main view without having to disable it altogether. This can be a useful function for varying product testing in which specific programs are used for different product tests. It allows a program, where product control is required, to turn it on through the event when run, and does not require the operator to ensure that the correct control mode is selected.

5.5.1 Using Product Control

The key to using product control, or even if it is necessary for your testing purposes, is understanding your product and what temperature conditions you want to test it under. There are several other factors that also come in to play such as the product shape, location in the chamber and most importantly, air flow over the product.

5.5.1.1 Should I Use Product Control for My Test

It is important to remember that it is the chamber air that is adding or removing heat from your product, and there must be a difference in temperature between them in order to do this. The larger this difference, the more heat that flows. Additionally, the more air moves across your product, the more heat can be added or removed at any given temperature difference.

Product placement in a chamber can affect the rate at which product changes temperature. It is important to not overload a chamber since blocking or restricting airflow will reduce performance and can prevent some of the product from seeing the proper test conditions. Product should be located in such a way that it gets good air distribution around it. While this may not be always possible due to certain circumstances, such as product shape, it is a factor to consider whenever possible.

Product Placement

Typically, the most detrimental affects are caused when shelves are used in a chamber and not enough free space around the product is provided for proper air flow. It is more beneficial to use multiple shelves with staggered product placement than to overload a shelf. Regardless of the number of shelves, staggering product is a must.

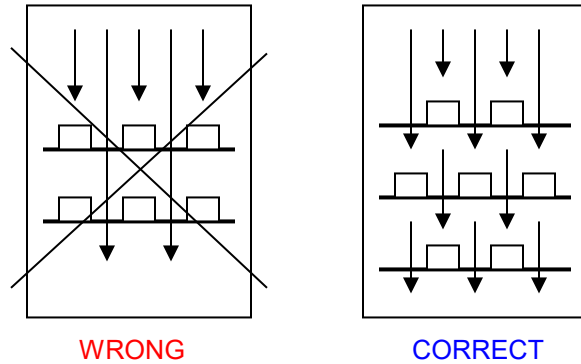

Once product is correctly positioned in the chamber, the need for product control depends on how the product responds to the test program and if the test requirements demand that the product be at a specific temperature. Small product placed inside a chamber with adequate airflow over them should follow the air temperature relatively close. However, large and/or dense product may lag behind air temperature.

This may require the test cycle to be extended in order to allow longer soak periods to provide enough time for the product to reach air temperature. Again, due to the need for a temperature difference to force the heat to move between the product and air, the product may never reach air temperature. If the test requirements specify that the product must be at the designated temperature, using product control is the only effective way to do this in the shortest cycle time possible.

Since speed for product to market is always desired, the need for faster test cycles is a necessity. Thus, if your testing needs are leaning towards the use of product control, it is important to implement it correctly for your product. Since the response that every product will have to a test program is an unknown, the exact settings for every situation cannot be predetermined. However, the following sections provide guidance on where to start. They provide assistance for the two “known” types of product loads that can be placed within a chamber; a dead load or a live load.

5.5.1.2 Implementing Product Control on “Dead Loads”

A “dead load” is a term describing a product that does not generate heat. Any product can be a dead load, even if it is an electrical product, as long as it is not powered during the test. Dead loads lag behind the air temperature when increasing or decreasing temperature. Since they lag in both directions, the product control settings need to be adjusted in order to allow the air temperature to go above and below the desired product temperature in order to drive it to set point.

In determining the upper and lower set point limits for product control, it is important to consider the maximum and minimum air temperatures that your product can be exposed to. Since the air temperature will exceed the product temperature in order to get it to set point, the air temperature could exceed the maximum or minimum air temperature that the product should be exposed to at any given time. Therefore, it should be considered when selecting the product control mode and set points.

Deviation Control

Deviation control uses the lower and upper set points as minimum and maximum offsets from the product set point. In other words, these values are subtracted and added to the product set point to create an air temperature set point range. For example, if you enter a product loop set point of 50 degrees, with a lower product control set point of -20.0 and an upper product control set point of 20.0, the air temperature control loop will be given a set point from the product loop in the range of 30.0 to 70.0 degrees as required to get the product to set point.

Therefore, as the product set point is changed, the deviation band changes with it so you always maintain an air temperature control range around the product set point. This provides a stable and accurate control method throughout the product's test range. Knowing what values to set for the lower and upper set points may require some trial and error.

A good starting point is to run a simple air temperature control test where you set the air temperature set point (no product control) to the upper test set point and then the lower test set point in order to see how the product responds to the changing air temperature. During the transitions, monitor the difference between the air temperature and the product temperature. Using the maximum difference observed, double the value and use that as the lower set point. The upper set point should then be set to four times that difference.

The reason for the larger offset on the heating side (upper set point) is due to the fact that when air temperature increases, its density decreases. Cooler air is denser and thus has greater heat content than warmer air. This increase in density transfers more heat between the product and air than at warmer temperatures. Therefore, a larger deviation is required at warmer air temperatures in order to maintain the same rate of heat transfer with the product.

Process Control

If there is a minimum and maximum air temperature that the product can be exposed too, which is, or very close to, the minimum and maximum product temperature you need to achieve, process control may be the better choice. This allows you to set the upper and lower set point limits that the air temperature is allowed to reach regardless of the product temperature set point.

For example, if a product test requires it to run between 70 and -20, but the air temperature is not to exceed 75 or -25, you can set the upper and lower product control set points to 75 and -25. The air temperature loop will then be sent a set point between 75 and -25 regardless of what the product set point is. This will maximize the rate of change of the product temperature by allowing the air temperature set points to reach maximum limits. However, once the product reaches set point, the larger air temperature control range may cause undesired oscillation once set point is achieved.

5.5.1.3 Implementing Product Control on “Live Loads”

A “live load” is a term describing a product that generates heat. This is typically some type of electrical product that is being tested while under power. Live loads tend to lead the air temperature when increasing in temperature, and can severely lag behind the air temperature when decreasing in temperature since they are self-heating. Since they usually lag in only one direction, the product control settings usually need to be adjusted to go considerably below the desired product temperature in order to drive it to set point. The upper set point is typically a smaller value.

When using product control on a live load, the location of the product temperature sensor is critical. Since the product is generating heat, placing the sensor on a heated component as compared to a non-heated surface, like a portion of the product case, will dramatically affect performance and test results. It is up to the user as to what component or location on the product is required to get the proper test results. Just consider that if the sensor is placed on a heated surface, the chamber may not be able to control it to the desired temperature due to airflow constraints or the amount of heat being produced.

Deviation Control

Deviation control, when used for live loads, operates in the same manner as for dead loads described above; however, determining the lower and upper set point limits are where they differ. The maximum deviation between air temperature and product temperature should be found in the same manner as for dead loads, but the value is then applied differently.

A good starting point is to use the maximum deviation found for the upper set point and use three times the deviation for the lower set point. This allows the air temperature to drop further in order to increase the rate at which heat is pulled from the product in order to compensate for its internal heat generation.

Process Control

Process control also operates in the same manner for live loads as dead loads. However, due to the fact that the product is generating heat, process control is typically unstable and produces undesirable results with fluctuations and oscillation in temperature control. It is recommended to use deviation control mode for these applications.

5.5.1.4 Considerations When Applying Product Control

Product control is a powerful tool, and when used properly, can decrease test cycle times and provide more accurate and thorough product testing to ensure the quality of your product. However, it is important to consider all of the factors that may affect the test results.

Product Sensor Placement

Whether the product is a live load or a dead load, sensor location will play an important part in the test results. If the test method is correct, but you are not getting the desired results, try changing the location of the sensor on the product or change the orientation of the product within the chamber. This may provide the results you were expecting.

Humidity Control

Relative humidity is a measurement of the amount of moisture in air at a given temperature as a percentage of the total water it could hold at that temperature. If your test requires both humidity and temperature control, product control may have a detrimental effect on the chamber's ability to control humidity. Since the air temperature varies in order to maintain product temperature, humidity control will be affected by the difference in air temperature required to get the product to temperature. The magnitude of this affect will be dependent upon your test conditions. Under some conditions, product control may have to be turned off in order to achieve the test results you require, or more extensive or tighter product control set point adjustments may be required.

5.5.1.5 How do I Know when Product Control is Active?

When product control is not active, the product set point will follow the temperature set point. As the temperature set point is changed, the product set point will automatically change with it. If you attempt to change the product set point, the set point entered will revert back to the temperature set point.

When product control is active, the temperature set point will be controlled by the product loop. The temperature set point typically varies readily as the product loop drives temperature. The product set point will also take user entry and control the value entered via the numeric keypad. The "temperature" set point is then entered on the product loop as the EZT-570S is now controlling product temperature.

The "units" display on the Main and Overview screens will also display the text "DUT Active" instead of the temperature units, i.e., C or F. This provides the user with direct status indication that product control is active and the temperature loop is under product loop control.

5.6 Condensation Control

The optional condensation control feature is for situations in which condensation is undesirable or detrimental to the product being tested. When enabled, the rate of rise in temperature is limited in order to allow the humidity control system to strip moisture from the chamber in order to keep the dewpoint of the air below the product temperature. If the dewpoint of the air were to exceed the product temperature, moisture could form on the product's surface.

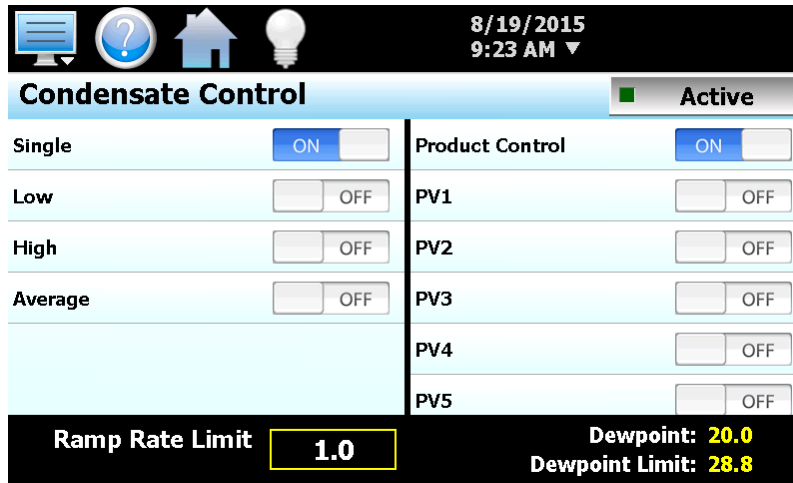

Figure 5-7 Condensation Control

There are many factors that can affect the performance of the chamber including product placement, mass of product and air distribution throughout the chamber. The required ramp rate limit will be affected by these factors. It may take a little trial-and-error to determine what setting is best for your testing needs.

Ramp Rate Limit: Adjustable ramp rate limit. Valid range is from zero to 10.0°C (18.0°F). Note that a limit setting of zero will have no limiting effect on rate of rise.

Dewpoint: Read only parameter which displays current dewpoint of the air within the chamber.

Dewpoint Limit: Read only parameter which displays the maximum dewpoint that can be maintained without causing condensation on product.

Monitor Mode Selections

The list of selections on the left of the screen is used to define the method of part temperature monitoring (only one can be selected at a time, i.e., turning on one will turn off the other selections).

- Single:** Uses single input, i.e., single sensor located on part.
- Low:** Uses input with the lowest part temperature.
- High:** Uses input with highest part temperature.
- Average:** Uses average of all selected part temperature inputs.

Input Selections

The list of selections on the right of the screen is used to select which inputs will be used for monitoring part temperature. Note that the standard system has only one selection, the product control loop input. If the EZT-570S is equipped with the input monitor option, the additional inputs will be listed for selection.

5.7 Defrost Settings

These settings will be available on chambers equipped with defrost. This option is typically provided on systems that must operate at low temperatures for extended periods of time or where frequent entry into the chamber is required. It is used to periodically warm the refrigeration coils and remove the normal accumulation of ice that occurs when running at low temperatures.

Moisture in the air is naturally attracted to the cold surface of the refrigeration coils in the chamber. This moisture freezes to the surface of the coil over time and can eventually cover the entire surface. This will render the coil useless and block all airflow in the chamber. In chambers that run through high and low temperature cycles, the moisture does not accumulate to a detrimental level, but in chambers that run at low temperatures for days or weeks at a time, this can be a problem.

Defrost is a means of warming the refrigeration coils to melt the ice, while minimizing the rise in temperature of product within the chamber. When defrost is enabled, the air circulators shut down and the hot-gas solenoid opens. The hot gas flows through the refrigeration coil and melts the ice. Once the coil reaches a preset temperature limit, typically 10°C (50°F), defrost terminates. The refrigeration system then pre-cools the coil prior to turning on the air circulators. This further prevents the warming of the chamber's contents.

Defrost can be set to run automatically or under manual control through the use of an event. When auto mode is selected, the EZT-570S will monitor the conditions of operation and automatically start defrost based on the parameters the user has entered.

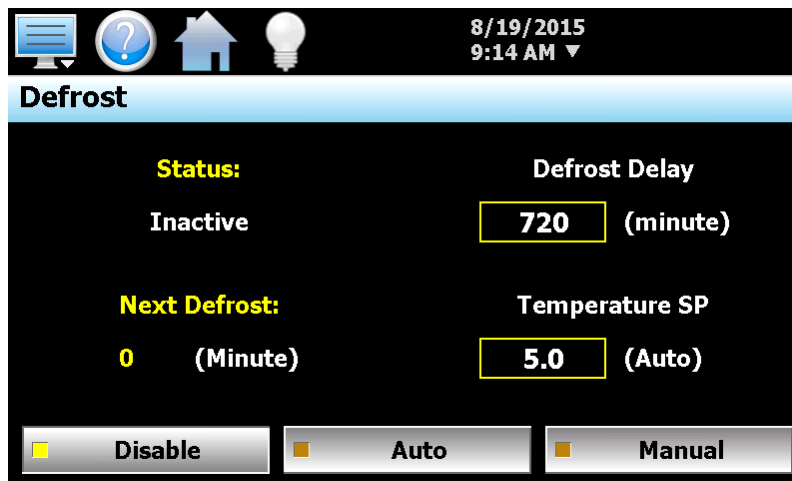

Figure 5-8 Defrost Settings

Defrost Delay: Time in minutes between defrosts when auto mode is enabled. This is based on Individual operating conditions. It may take some analysis to determine how long your chamber can run before defrost is required.

Temperature SP: Temperature below which defrost is enabled when in auto mode and after the defrost delay, defrost will be activated. If at any time the chamber temperature rises above the set point temperature, the delay timer will be reset and the countdown will begin anew the next time the chamber temperature drops below the set point.

This prevents defrost from starting at temperatures above which ice does not form on the cooling coils.

5.8 Communication Settings

The User communications screen is used to set up and configure the EZT-570S communication interfaces. For more information regarding the use of the EZT-570S data communications interfaces, see Section 9, Communications.

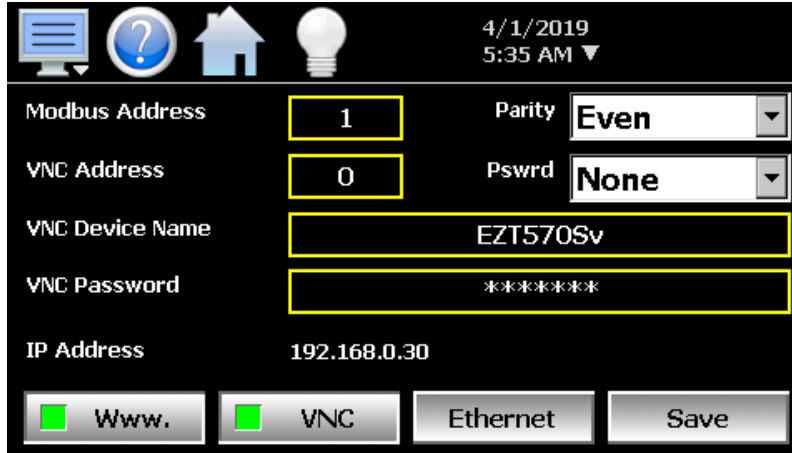

Figure 5-9 Communication Settings

The **Modbus Address/Parity** settings are used to configure the EZT-570S’s serial interface. The Modbus address sets the address of the EZT-570S on the serial communications link. Valid addresses are 1 to 247. The parity setting allows the EZT-570S’s serial port to be set for even, odd or no (none) parity.

The Modbus Address is also used to specify the unit ID for Modbus TCP communications. Modbus TCP communications is provided over the Ethernet interface on port 502.

The **VNC Address and Password** set access rights to the EZT-570S VNC server. Valid addresses are from 0 to 99. The VNC password selection defines the connection mode for the server. The selections are “None” and “VncAuth” which requires users to enter the password when connecting to EZT-570S over the VNC interface.

! *When multiple chambers are connected to a single router (DHCP server), it is imperative that each EZT-570S have a different VNC address. If multiple chambers have the same VNC address, network errors may result causing the VNC server to shut down or cause the EZT-570S to “lock-up” and become non-responsive requiring the unit to be power cycled in order to return to normal operation.*

The **VNC Device Name** field is used to enter a name (up to 35 characters) that can better identify the chamber to users logged into the VNC interface. The name entered here will be used on the VNC header window on a PC, so that if multiple VNC clients are open to different chambers, each one can be identified.

The **VNC Password** field is used to enter the password (up to 20 characters) that a user must enter for the VNC interface to connect to the EZT-570S if the VNC password is enabled.

The **Www.** (web server) pushbutton is used to enable or disable the web server interface.

The **VNC** server pushbutton is used to enable or disable the VNC server interface.

The **IP Address** field is a static field that provides the IP address of the EZT-570S which is required for connecting over the VNC, web and Modbus TCP server interfaces. See the following section 5.8.1 Ethernet Settings for more information on how to adjust the device IP and other LAN information.

! Any changes made to the above settings must be saved in order for them to take effect. When changes are completed, press the “Save” button. In order for any changes to the VNC server to take effect, power must also be cycled to the EZT-570S. The new VNC settings will only take effect when EZT-570S first boots up. Serial communication and web server settings take effect immediately upon save.

5.8.1 10/100 Base-T Ethernet Settings

The “Ethernet” screen provides settings for the network interface of the EZT-570S. It is accessed by pressing the Ethernet button on the Communications screen.

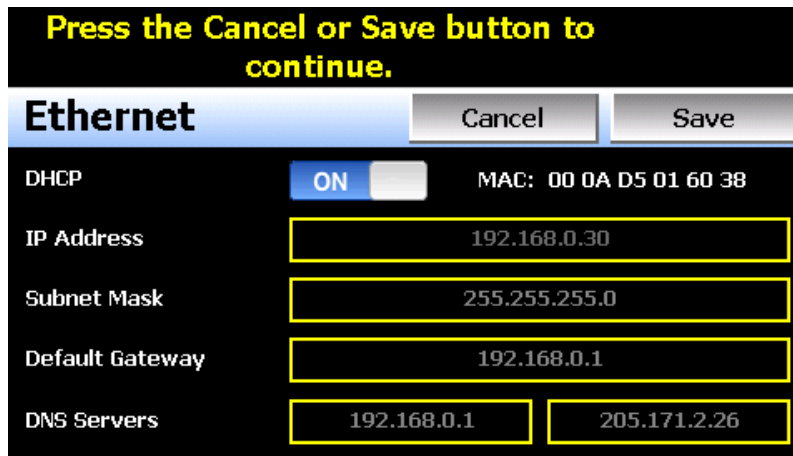

Figure 5-10 Ethernet Settings

The **MAC** address field displays the media access control address (physical address) of the EZT-570S. This is a unique identifier for the network hardware of the EZT-570S and cannot be changed. It is for informational purposes and may be required by your network administrator when connecting the EZT-570S to your network.

The **DHCP** button is used to turn automatic addressing on and off. By default, the EZT-570S is shipped with the DHCP setting on. This means the EZT-570S will be assigned an IP address by the network router. When on, the entry fields will be disabled, but will display current connection information used by the EZT-570S. In order to enter a static address, press the button to turn it off.

To set the static network address, enter a valid **IP Address**, **Subnet Mask** and **Default Gateway**. The **DNS Servers** are not required, but typically the IP address of the network router is entered to provide one. Consult your network administrator for the proper values. The IP address must not be a duplicate of any other address on the network or the interface will not operate correctly. The entry fields except IPV4 addressing format only. The EZT-570S does not except IPV6 addressing.

! When DHCP is on and the EZT-570S is disconnected from the network, the entry fields on the Ethernet screen will continue to display connection information based on its last valid connection for diagnostic purposes. The IP address on the main Communications screen (or shown in the notifications list) always displays the current address used by the EZT-570S. If the IP address on the Communications screen displays the loop-back address of “127.0.0.1” then no connection is present.

When DHCP is off, the IP address on the Communications screen will always display the user entered static IP address regardless of connection status. It does not indicate whether a valid network connection is present or not.

5.9 Barcode Reader

The Barcode screen provides access to the settings for the optional barcode reader. These include settings to turn the barcode reader on and off, applying a prefix to scanned data and a test window for verifying proper operation.

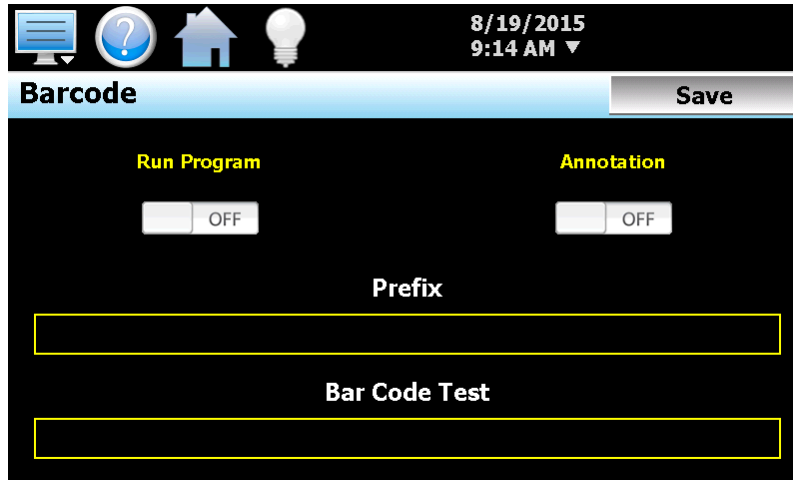

Figure 5-11 Barcode Reader

Barcode reader operation is enabled through the ‘Start the automatic program’ and ‘Annotation’ on/off buttons. The selections are mutually exclusive, i.e., only one can be enabled at a time. When one option is turned on, the other is automatically turned off.

When the **Start the automatic program** option is turned on, if the scanned data matches the name of a ramp/soak program stored in memory, the EZT-570S will automatically load the program and prompt the user to start it. If the user presses ‘Yes’ to start the program it will be downloaded to the control module and will begin operation on the first step.

When the **Annotation** option is turned on, the scanned data will be written to the currently running data log file as operator event.

The **Prefix** field allows the user to enter up to 16 characters that will then be used as a prefix to the scanned value when matching a ramp/soak program name or when it is inserted into the active data log file. This can be used as a tag to describe what the scanned value represents, i.e., Lot or Batch number for example.

! *Any changes made to the above settings must be saved in order for them to take effect. When changes are complete, press the ‘Save’ button to save the new settings in order to use them.*

The **Bar Code Test** field allows the operator to test the operation of the barcode scanner. As a bar code is swiped by the reader, the scanned value will appear in this field. If upon scanning a bar code, no value appears in this field, check the wiring and communication settings of the barcode scanner to be sure that it is connected and set up properly.

5.9.1 Barcode Reader Communication Settings

In order for the barcode reader to communicate properly with the EZT-570S, it must be set with the proper communication settings. This includes baud rate, data bits, stop bits, parity and start/end of transmission characters as follows:

Baud rate = 9600 baud
Data bits = 7
Stop bits = 1
Parity = even
Preamble = STX (0x02)
Postamble = ETX (0x03)

The preamble and postamble are the start of transmission and end of transmission characters that must be used to frame the barcode transmitted to the EZT-570S so that it recognizes the beginning and end of the transmission. All other terminator, BCC, ACK and/or handshaking characters must be disabled. See the user manual for the barcode scanner being used for instructions on how to configure the proper communication settings.

5.9.2 Important Notes on Barcode Reader Use

There are certain limitations of use for the barcode reader based on the mode of operation selected. It is important that the user read and understand these to ensure that the barcode reader operates as expected.

5.9.2.1 Using the Barcode Reader to Start an Automatic Ramp/Soak Program

When using the barcode reader to start a program, the scanned barcode data must match the ramp/soak program name exactly in order for the EZT-570S to load and prompt the user to start it. Program names can be a maximum of 16 characters, which also matches the maximum data that the EZT-570S will accept from the barcode scanner. However, if a prefix is also used, the overall name (prefix + scanned data) can exceed the maximum allowed file name length for a program. If the EZT-570S does not find an exact match, it will ignore the scan. Thus, it is up to the user to ensure that a matching program exists for each bar code that will be scanned.

If an automatic ramp soak program is already in operation, or a program download is active from a remote PC, the EZT-570S will ignore any barcode scan made during that time. The EZT-570S will also ignore a barcode scan if the FTP data backup is active. The user must manually stop the currently running program or wait for the remote PC download to complete before scanning the barcode to begin the matching program. The user also has the option of cancelling the FTP data backup while it is in progress if necessary, in order to scan and start a program.

If the automatic FTP data backup is set to occur while an automatic program start is in progress by a barcode scan, but the user has not yet acknowledged the request to start the program, the FTP data backup will be skipped. The automatic FTP data backup will then occur at the next scheduled interval. This allows the user to proceed without interruption; however, it does prevent the scheduled backup of data. If necessary, a manual FTP backup can be performed once the program has been started.

5.9.2.2 Using the Barcode Reader to Annotate a Data Log File

When scanning bar codes, a minimum time period of 3 seconds is required between each code scanned. This provides the time necessary for the EZT-570S to acquire the code and insert it as an annotation into a running log file. If multiple bar codes are scanned too quickly, the EZT-570S may miss a scan because it is still processing the previous bar code.

5.10 Email

The EZT-570S email server has the ability to send alarm messages to email and SMS addresses. Up to 30 addresses can be programmed into the system. Each one can be configured to receive emails, SMS text messages or both. When an alarm occurs, the EZT-570S will send an alert to the specified address for each user in the list. The email settings are accessed by selecting "Email" from the setup "Email" menu.

5.10.1 Address Entry

Select the "New" tab to add new email addresses to the system. For each entry, enter the recipient's Name, Email Address and/or SMS Number (up to 50 characters each). Turn on the Email Alarm and/or SMS Alarm options to specify which addresses the alarm messages are to be sent to. Press the "Create" button to add the user to the list.

Figure 5-12 Create Email Address

! *The SMS address is specific to the service provider. Each service provider has their own unique address; however, the phone number is always the "name" for the address entry. There are internet sites with this information that cover most of the providers, or when in doubt, contact your service provider for the proper address format.*

5.10.2 Email Addresses

Selecting the "Addresses" tab allows the user to view the list of email addresses entered into the EZT-570S. Each entry will be shown with the notification method and address associated with it (email/SMS). To delete a user, touch the name of the user in the list box and press the "Delete" button. This will permanently remove the user from the list.

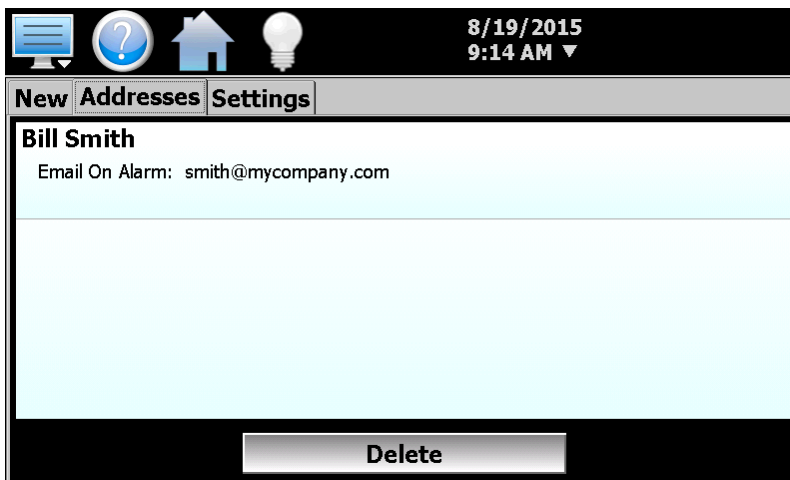

Figure 5-13 Email Addresses

5.10.3 Email Settings

The “Settings” tab provides access to the email server configuration, which is how the EZT-570S is able to connect and send email messages over its Ethernet connection. Each field may have up to 50 characters.

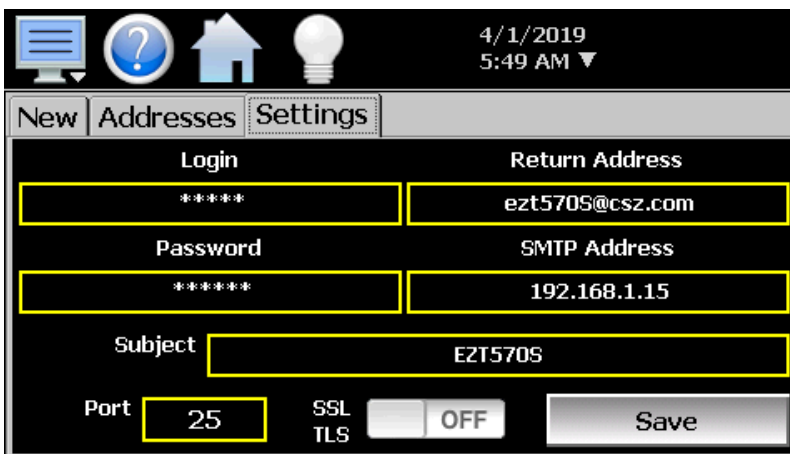



Figure 5-14 Email Settings

! *These settings may require authorization and/or assistance from your system administrator. Contact your system administrator for proper settings and network authorization from your network server (if required) to allow the EZT-570S to send email/SMS text messages.*

Login: The login field is used to enter the login name required by the EZT-570S to log into your company’s mail server. You can use your login if one is not set up specifically for the EZT-570S on your network. The login name will be displayed in password format as “****” for security. Contact your system administrator for assistance.

Password: The password field is used for entering a password, if required by your network server, to send email. Typically, a password is not required for sending email, only to receive email. The password will be displayed as “*****” for security.

 *If a login and/or password are required, it is recommended to contact your system administrator and have them set up an account specifically for the EZT-570S for security purposes. The login and password fields can be left blank if your company's email server permits emails to be sent anonymously.*

Return Address: The return address is the address given for the EZT-570S on your company's mail server. The EZT-570S does not except email messages; however, this field is required for proper email delivery for security/anti-spam purposes. You can also use your personal email address if one is not set up specifically for the EZT-570S on your network. Contact your system administrator for assistance.

SMTP Address: This field is for entering the address of the email server used for sending emails. This must be a valid mail server for which the above settings allow the EZT-570S access. Contact your system administrator for assistance.

Subject: This field is used to enter a subject line for emails and/or SMS text messages. It can be used to provide an identifier to the recipients of the alarm message to know which chamber it is coming from.

 *It is recommended to put some form of entry in this field. It can be left blank; however, many firewalls and spam filters will filter out messages without subject lines. That may prevent recipients from receiving the email. It can also be useful for identifying a particular chamber on the factory floor.*

Port: This field is for entering the network port that the email client is to use when accessing the email server in order to send emails. The default port number is 25. The port can be set to a value between 0 and 65535. Contact your system administrator for assistance.

SSL/TLS: This button is used to enable or disable Secure Socket Layer (SSL) and Transport Security Layer (TLS) functionality. These protocols are used to provide an authenticated connection between servers and clients as well as encrypt information between the two. This provides a more secure environment for email information with many public email services only allowing SSL/TLS connectivity.

Once all settings have been made, be sure to press the "Save" button to begin using the new values and store them, so that on the next power up, the settings will be retained. The body of the email/SMS text message will contain the description of the alarm condition as it would appear on the alarm screen. If the mail server is down, or the EZT-570S is not connected to the network, the message will not be sent and a local alarm message on the alarm screen will indicate a transmission failure.

 *The EZT-570S must have a valid connection to your network for the email server to operate. The EZT-570S receives its IP address from DHCP on your network unless it has been configured to use a static IP. If the EZT-570S is unable to send emails, verify that the EZT-570S IP address is a valid address in your network.*

5.10.4 Sending Email Messages

The EZT-570S provides the ability to send short email messages to addresses programmed into its email server. To send a message, select “Message” from the device settings, Email menu.

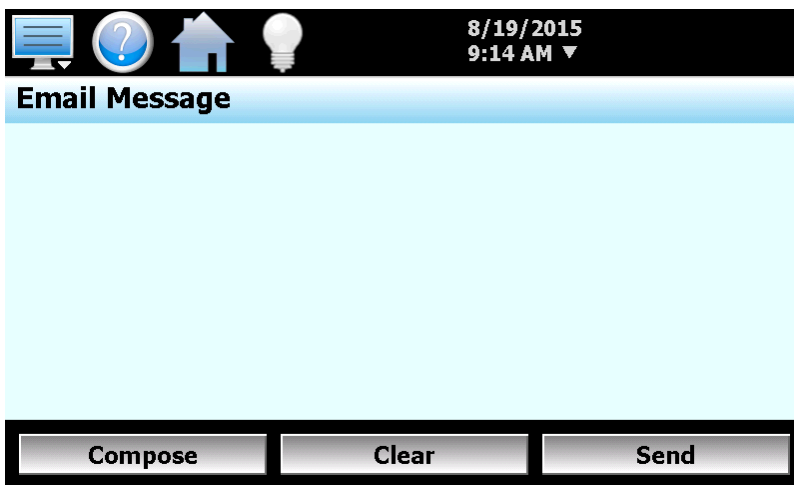

Figure 5-15 Send Email Message

Press the “Compose” button to create a brief message using the keypad (up to 100 characters). When you are finished entering the message, press the “Enter” button. The completed message will then be shown in the message window. Press the “Send” button to select the email recipients you wish to receive the message and send the message.

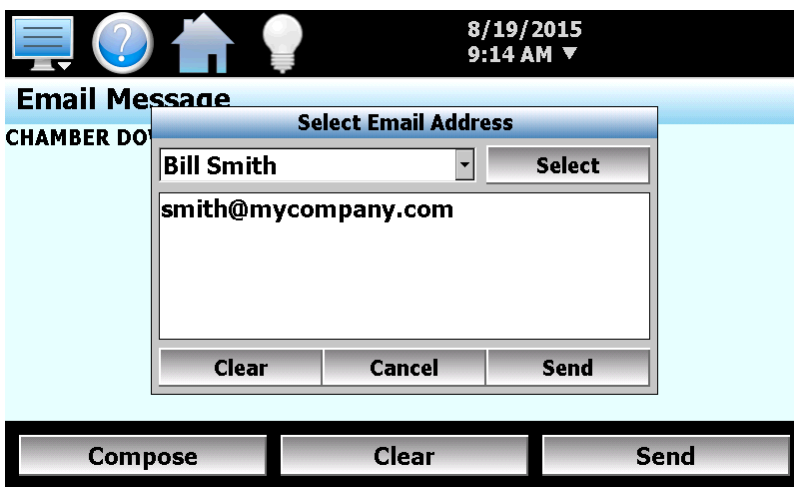

Figure 5-16 Select Email Address

Use the drop-down menu to select from the available list of email addresses and press the “Select” button to add that recipient to the list. Multiple email recipients can be added by individually selecting them. Once all of the desired recipients have been added, press the “Send” button to send the message.

5.11 Navigation

The EZT-570S provides both text-based PC style menus and icon based/slide page navigation menus similar to today's "smart" devices. The user can select either type at any time from the Navigation screen.

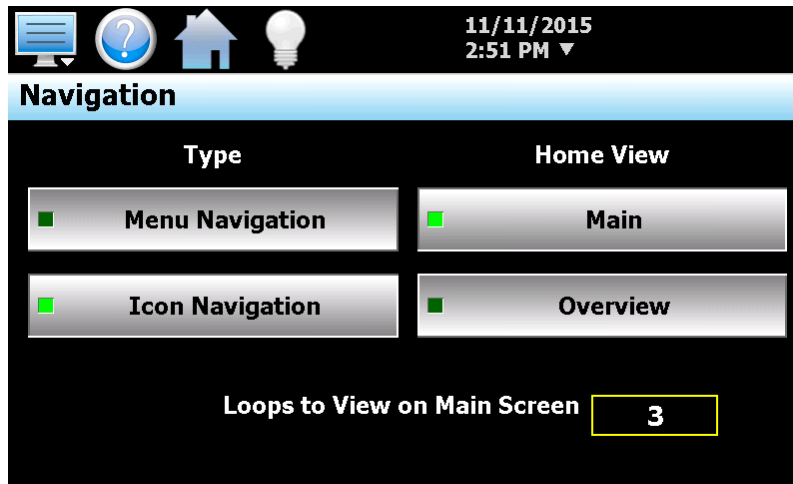

Figure 5-17 Navigation

Press the button for the desired navigation type to make the selection. The choices are mutually exclusive, so when one selection is made, the other will be de-selected. The button indicator for the active selection will illuminate to show the current selection.

The EZT-570S also offers the ability to choose the screen that will be displayed when pressing the "Home" icon. To choose the home view, press the button for the desired screen, either the Main loop view or Overview screen. The selections are mutually exclusive, so when one selection is made the other will be de-selected. The button indicator for the active selection will illuminate to show the current selection.

The **Loops to View on Main Screen** allows the user to select how many loops will be shown on the main screen. The entry can be from one up to five loops. The maximum number is limited by the available loops and monitor points on the system. A typical temperature and humidity chamber has three loops, i.e., temperature, humidity and product. This would limit the maximum to three.

5.12 Tuning

The Tuning screen allows for both manual and automatic tuning of the EZT-570S control loops. All CSZ chambers are factory tuned; however, the chambers are typically empty and under no load. Unless specific performance tests were performed at the factory for your particular needs, the base-line performance may not be accurate once your product is placed inside the chamber.

Tuning parameters should only be adjusted by skilled users familiar with proportional control. Improper settings can result in control loop instability and equipment damage. All of the EZT-570S control loops feature an automatic tune function which is the recommended method of loop tuning. If the control response achieved after performing an auto tune does not provide the desired control response, then minor adjustment of the tuning parameters may be done to obtain the desired response.

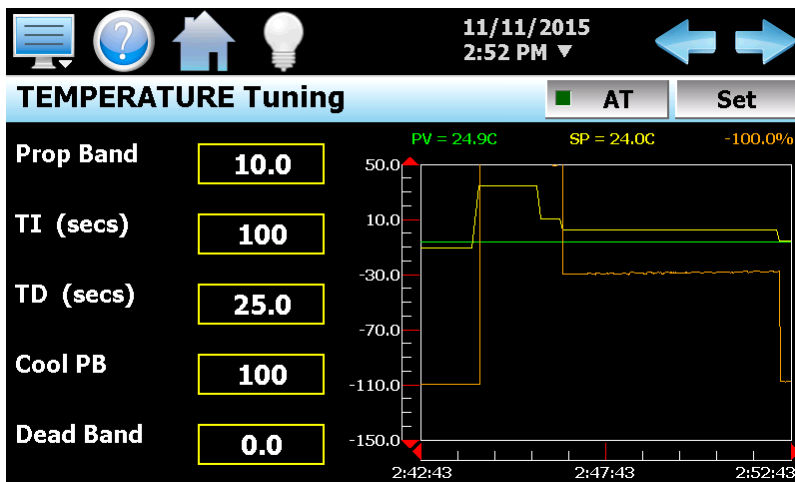

Figure 5-18 Tuning

The tune screen also provides a live real time chart for monitoring the control response of the control loop while adjusting tuning parameters. The chart is fixed at a 10-minute time period and updates once per second.

The **left** and **right arrow buttons** at the top right corner of the screen will cycle through each loop available. By pressing either button, the previous or next loop will appear in sequential order. When the first or last loop is reached, the EZT-570S will automatically wrap around to the beginning or end of the list to show the next loop. If the system has only one loop, the arrow buttons will not be shown.

The **Set** button allows the user to adjust the loop set point without having to leave the tuning screen in order to observe the control response.

The **AT** button is provided to activate the automatic tune function of the control loop. During the auto tune procedure, the button indicator will be on to show the tune is in progress. When the tune is complete, the button's indicator will automatically turn off to indicate the tune is complete. If at any time during the tune process, you want to cancel the auto tune, press the button to cancel the tune.

It is recommended that only one loop be tuned at a time. Temperature for example, affects humidity. If the EZT-570S is currently tuning temperature and auto tune were activated on the humidity loop as well, any fluctuation in air temperature during its tuning process can affect the tuning process of the humidity loop. By tuning chamber temperature first and allowing it to stabilize prior to activating the humidity loop tune, it will ensure that the humidity control loop gets an accurate base-line performance reading on the chamber.

The **Proportional Band** is in the units of measurement for the control loop. On temperature for example, a proportional band of 10 would be 10 degrees. Thus, as the PV drops below set point by 0 to 10 degrees, the output would go from 0 to 100% for full heat.

The **Cooling PB** is measured in % of the proportional band with a range 50-300. If cooling action should be enhanced then decrease the band. If cooling action is too strong then increase the cooling band. The value of the cooling proportional band is related to the heating proportional band and its value remains unchanged throughout any auto tuning procedures. Only the proportional band, TI and TD factors are determined by auto tune.

The cooling proportional band is typically set at a default value of 100% from the factory as chamber design balances heating and cooling capacities. Under certain conditions however, it may be necessary to increase the cooling side response when testing live loads that produce a lot of heat.

The **TI** and **TD** values for reset and rate are both entered in seconds and affect both heating and cooling response. Large values for TI will slow down the control response while smaller values will speed up the reset action. Having too large of a value can make the chamber sluggish in response to process changes while too small of a value can cause oscillation.

A larger TD factor can help reduce overshoot; however, it can also make the output respond too rapidly to small changes in the process and prevent the chamber from every reaching set point. Too small of a value will usually result in the chamber getting to set point quickly under small process changes, but may result in greater than desired overshoot.

The adjustment of **Dead Band** is more dependent upon system requirements. If more positive values of dead band (greater dead band) are used, an unwanted cooling action can be avoided but an excessive overshoot may occur. If more negative values of dead band (greater overlap) are used, an excessive overshoot can be minimized but an unwanted cooling action may occur.

Dead band is adjustable in the range of -36.0% to 36.0 % of the heating proportional band. A negative dead band value provides an overlap between heating and cooling in which both outputs are active. A positive dead band value provides a dead band area in which neither output is active around set point. This value is rarely used and it is recommended to leave it at the default value of 0.0.

6. Security

The EZT-570S security model provides an administrator with the tools to add up to 30 users to the system. Each user must have a unique ID, full name and password. Four user levels are provided which include system, user, supervisor and administrator levels. Specific access rights can be assigned to each user level and password aging can be implemented. Verification is provided (if enabled) for any parameters that will change a control parameter, which could upset the process (i.e. loop set point, start/stop automated ramp/soak programs, etc.).

Verification requires that the logged in user must log in again before the process value will actually be changed. This feature is provided for extra security. The following example will make verification clearer:

A supervisor logs on the system. The supervisor then steps away from the system to take a phone call but does not log out before leaving. If another user tries to change the temperature control set point, the system will require another login (by an authorized user for that level) before the control set point is actually changed. This provides an extra level of protection to make the system more “tamper proof”.

The ‘Security’ menu, accessed from the home menu, provides access to the security section of the EZT-570S.

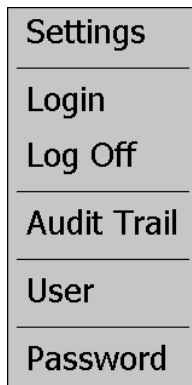

The ‘Security’ menu provides the following functions:

Settings:	Provides access to security setup to add users, set rights and options.
Login:	Log on a user if security is enabled.
Log Off	Log off a user if security is enabled.
Audit Trail:	Allows the user to view any of the saved audit trail files.
User:	Shows the current user logged into the system.
Password:	Allows the current user to change their password.



Default **UserID** is “FACTORY”.
Default **Password** is “CONTROL”

6.1 Adding Users

The “New” user tab provides the ability to add up to 30 users to the system. Select the type of user from the drop-down list (System, User, Supervisor or Administrator). Press each field to add the user ID, full name and password (no spaces allowed, 5 character minimum and 16 characters maximum). Press the “Create” button to add the user to the system.

The screenshot shows a mobile application interface for adding a new user. At the top, there are navigation icons (home, help, lightbulb) and a status bar showing the date and time (8/19/2015, 9:14 AM). Below the navigation is a tab bar with 'New', 'Users', 'Access', and 'Options'. The 'New' tab is selected. The main form area has a 'User Type' dropdown menu set to 'User' and a 'Create' button. Below this are four input fields: 'User ID' containing 'MLAMBERT', 'Name' containing 'MARK LAMBERT', 'Password' containing '*****', and 'Confirm Password' containing '*****'.

Figure 6-1 Security (New User)

! You must have at least one user with administrator access in order to turn on security. There is no “back door” to the system. If the password is lost or forgotten, you must contact our Service Department for support.

6.2 Viewing Users

The “Users” tab provides the administrator with the ability to view information on each user entered into the system. Password information is not available. The user can be deleted from this tab and a new password for each user can also be entered from this area.

The screenshot shows the 'Users' tab in the Security application. The tab bar at the top has 'New', 'Users', 'Access', and 'Options', with 'Users' selected. The main content area shows a list of users. The first user is 'FACTORY (FACTORY)', with the role 'Administrator' and 'Updated On: 10/16/2014'. Below the list are two buttons: 'Delete' and 'Password'.

Figure 6-2 Security (Users)

To delete a user, select the user from the list and press the “Delete” button. Likewise, to change the password for a user, select the user from the list and press the “Password” button.

6.2.1 New Password Entry

To change a password, select the desired user by touching the User ID in the list box and press the ‘New Password’ button. Enter the new password and confirm the password. Press the ‘Save’ button to change the password (no spaces allowed, 5 character minimum and 16 characters maximum).

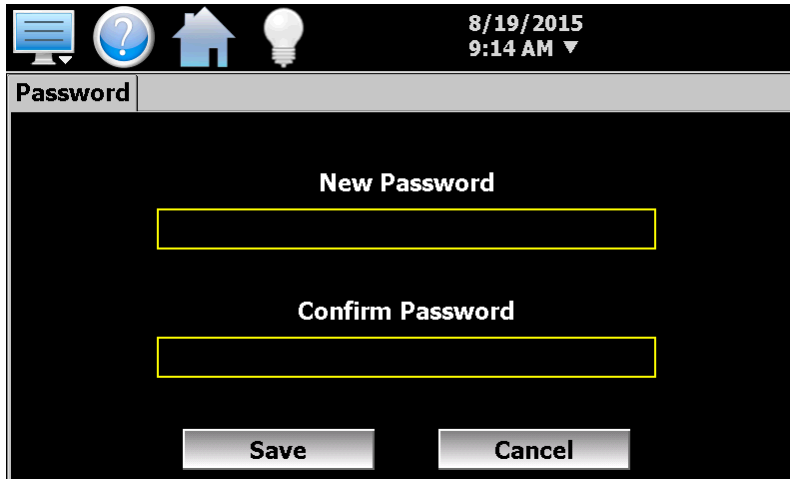

Figure 6-3 Change User Password

6.3 Setting User Access

The “Access” tab provides the administrator the ability to assign rights to each user level (System, User, Supervisor and Administrator). To enable or disable specific program functions (user rights) for each user level, select the user right from the list and press the corresponding on/off button for the user level you want to change access rights for. If the button is set to on, user access will be enabled for the user group.

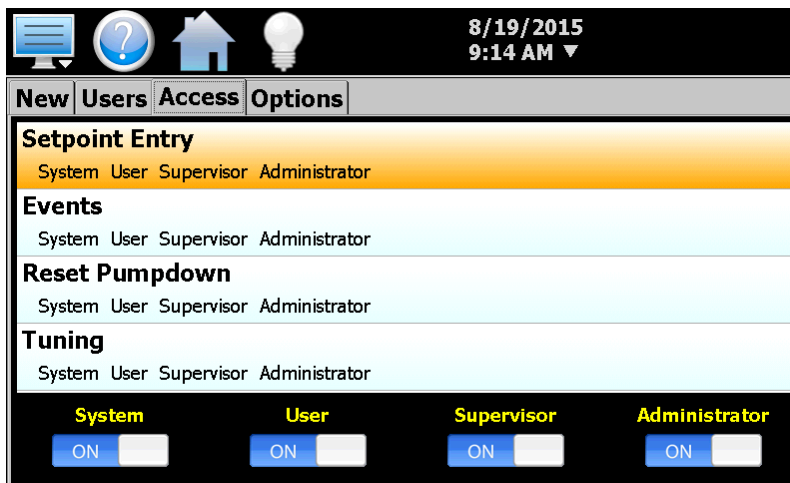

Figure 6-4 User Access Rights

User access for “Security” cannot be disabled for the administrator group. This is a safety feature to make sure that any administrator with the proper user ID and password can access security. If the administrator loses his/her ID or password, there is no “back door” to the system and it will have to be reset and reprogrammed in order to return to normal operation.

6.3.1 User Access Rights

The following table is a list of the available user rights, where to find the menu item(s) applicable to the user right and a description of what it applies to. Certain menu items may not be available on your chamber depending upon available options.

User Right	Menu Location	Description
Setpoint Entry	View/Main, Overview	applies to loop controls when not running an automatic ramp/soak program (does not apply to loop/monitor alarms)
Events	View/Overview,Main; Manual Operation	applies to enable or disable system events
Reset Pumpdown	View/Alarm; Pumpdown button	allows manual reset of pumpdown
Tuning	System/Settings/View/Tuning	allows activation of loop automatic tune function and manual adjustment of PID parameters
Program Operation	see description	applies to Start, Hold, Stop, Off actions; does not affect digital Inputs configured for same action
Recovery	System/Settings/Setup/Recovery	logic when running an automated ramp/soak program when power lost & recovery: Off, Hold, Continue, Restart or Resume
Reset Alarms	View/Alarm; Reset Button View/Status; Reset Button	allows user to reset and silence audible alarm
Clear Alarms	View/Alarm; Clear button	allows user to clear alarm list
Trend Setup	View/Trend; Setup button	configure plot channels, scale & time for trends
Data	Data/Logging	applies to all data logging actions & settings; does not affect digital input functions
Annotation	Data/Logging/View/Annotation	access to add operator messages to active log file
Signature	Data/ Logging /View/Signature	access to add digital signature to active historical data file
Open	see description	alarm, automatic program, audit & data files
Save	see description	program "save" and "save as"; note files may be copied from system with USB file transfer utilities
Delete	see description	data files & automatic programs; note files may be deleted with File Utilities
Program Edit	Program/Entry	no data entry or access to Events or Step SP/Time fields or G-Soak Limits, AutoStart; can't insert/delete/copy/paste step.
USB	Data/Logging/Utilities/USB	allows USB memory stick to copy/delete data, alarm, program & audit trail files & to import programs
FTP/WAN	Data/Logging/Utilities/FTP/WAN	configure FTP client settings, start manual backup
Communications	System/Settings/Comms/User	configure web page, Modbus address & VNC settings
Barcode	System/Settings/Comms/Barcode	applies to all barcode reader settings
Defrost	System/Settings/View/Defrost	applies to defrost mode, interval and set point
Product Control	System/Settings/Setup/Product	access to configure product control settings
Condensate Control	System/Settings/View/Condensation	access to configure condensation control settings
Monitor Names	System/Settings/Offline/Settings/ Calibrate/Offset	access to change optional monitor input names
Setpoint Limits	System/Settings/Setup/Setpoint Limits	applies to loop controls (does not apply to loop/monitor alarms)
Adjust Alarms	System/Settings/Setup/Alarm	applies to all loop and monitor point alarms
Event Names	System/Settings/Setup/Event Names	configure customer event names (seen in Overview & program step Events)
Email Settings	System/Settings/Email/Settings	configure email settings and addresses
Email Message	System/Settings/Email/Message	access to compose & send email message
Offline	System/Settings/Offline/Settings	access to Off-Line menu system: Service items & Options, Units, set Clock, Display settings, Language, Exit Application, monitor Offset, Configuration, Analog Input & Output Setup, Digital Input & Output Setup and Special Settings

User Right	Menu Location	Description
Service	System/Settings/Offline/Settings/View/Service Counters	applies to counter set point entry and clearing counters
Service Options	System/Settings/Offline/Settings/View/Service Options	service notification enable/disable
Calibrate Touch	System/Settings/Offline/Settings/System/Display	access to the touch screen calibration utility
Backlight	System/Settings/Offline/Settings/System/Display	access to edit backlight settings for brightness and off delay time
Alarm Volume	System/Settings/Offline/Settings/System/Display	allows edit of the EZT-570S display alarm beeper volume (does not apply to external alarm)
Units	System/Settings//Offline/Settings/Setup/Units	loop/monitor point temperature units configuration - C\F
Clock	System/Settings//Offline/Settings/Setup/Clock	Set Date/Time, Time Zone, DST and NTS connection
NTP	System/Settings//Offline/Settings/Setup/Clock	enable & choose National Time Server location
Daylight Savings	System/Settings//Offline/Settings/Setup/Clock	enable Daylight Savings Time (DST)
Language	System/Settings//Offline/Settings/Setup/Language	Select help language
Offset Calibration	System/Settings//Offline/Settings/Calibrate/Offset	enter bias for monitor points
Analog Inputs	System/Settings//Offline/Settings/Hardware/Analog Inputs	configure Analog Input(s) to act as remote set points for specific loop controls
Analog Outputs	System/Settings//Offline/Settings/Hardware/Analog Outputs	configuration of PV, SP or %out retransmission from specific loop controls
Digital Inputs	System/Settings//Offline/Settings/Hardware/Digital Inputs	configure Digital Inputs
Digital Outputs	System/Settings//Offline/Settings/Hardware/Digital Outputs	configure Digital Outputs (customer events)
Special Settings	System/Settings/Offline/Settings/Setup/Special	access to adjust special settings
Security	View/Security/Settings	applies to Security Setup
Configuration	System/Settings/Offline/Settings/System/Configuration	access to import/export setup files for the EZT-570S
Default Configuration	System/Settings/Offline/Settings/System/Configuration; Reset Default Configuration button	function to clear system configuration and reset to factory default state
Exit (run mode)	System/Settings /Offline/Settings/System/Exit; "Exit application. (automatic mode startup)." button	allows user to exit he EZT-570S application
Exit to Configurator	System/Settings /Offline/Settings/System/Exit; "Exit Application. (configuration mode startup)." button	allows user to exit the EZT-570S application and set the system to boot up in the configurator on the next power cycle

6.4 Setting Security Options

The security “Options” tab provides the administrator the ability to set the global security options.

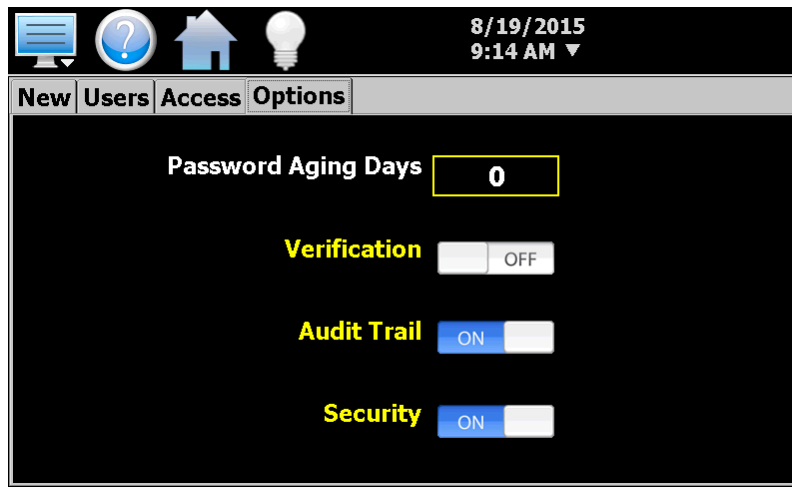



Figure 6-5 Security Options

The **Password Aging Days** field is a global for all users. Password aging starts from the day the user is entered into the system. The value can be set from 0 to 365 days. A value of zero disables password aging.

- 
 When using password aging and the password expires for a user, the user will be required to change their password before access to the system is permitted. A user can change their password at any time (even if aging is not used) by selecting “Password” from the main security menu.

When enabled, **Verification** requires that the logged in user must log in again before the process value will actually be changed.

Audit Trail is a global setting that turns the audit trail on or off. When the audit trail is turned on, all user actions are written to a daily log.

Security is the global setting that turns the EZT-570S security system on or off. The security system must be enabled for the audit trail to be enabled.

6.5 Audit Trail

The audit trail viewer is accessed by selecting “Audit” from the Security menu. It displays all user actions that affected the system for any given day. The EZT-570S can store daily audit files for a period of a year or longer (time based on storage usage for data logging). Each time a user takes an action that affect the operation of the system (changing a set point, start/stop data logging, changes an alarm set point, etc.), the action is written to a file. Audit trail file names are listed as MMDDYYYY (where MM = month, DD = day, YYYY = year. The “Open” file button will display a dialog box where the user can select any audit file to view.

 *If no actions occurred on a given day, an audit file will not be created for that day.*

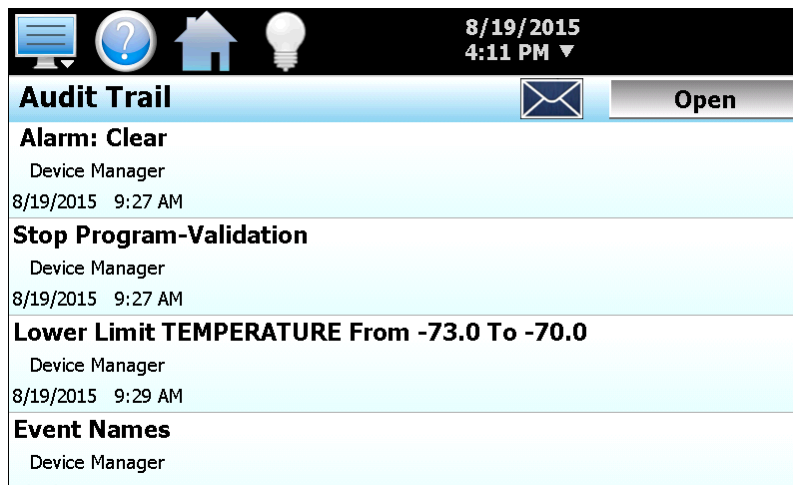



Figure 6-6 Audit Trail View

Each action recorded to the file includes the date/time it occurred as well as the user (if logged in) that made the change. If no user is logged in, the user will be listed as “Device Manager”, which is the default user account for the EZT-570S.

The send email icon  allows the user to send a copy of the currently opened audit trail file to any email address entered into the system. When the email icon is pressed, an “Add Recipients” window will be displayed where the user can select recipients for the file from any of the email addresses configured under the EZT-570S email settings. For information on how to add email recipients, see the section 5.10, Email.

 *Functions performed via the optional digital inputs, such as starting or stopping a ramp/soak program, are not logged to the audit trail. These are external inputs to the control module and are not protected by security.*

7. Data Logging

The EZT-570S data logging features are accessed via the home 'Data' menu item. The system data logging provides the ability to select individual points for logging, view data log files and start/stop logging operations. The logging ability of the EZT-570S provides an easy-to-use, convenient method to obtain electronic data without the need for additional data acquisition equipment.

The Data Log menu provides navigation to the following functions:

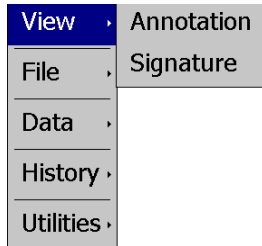

View menu

Annotation: Allows the user to insert a notification into the currently running log file or view all annotations associated with the currently loaded historical data file.

Signature: Allows the user to digitally sign a file to prevent data tampering and view all digital signatures associated with the currently loaded historical data file.

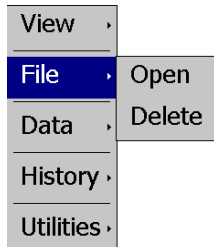

File menu

Open: Opens a history file for review.

Delete: Allows the user to delete the currently loaded history file.

NOTE: The "Delete" log file function does not affect data from a file that is running, only the current data log file loaded for review.

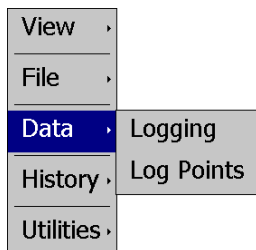

Data menu

Logging: Displays main data log screen with status of logger.

Log Points: Allows the user to select what variables are to be logged.

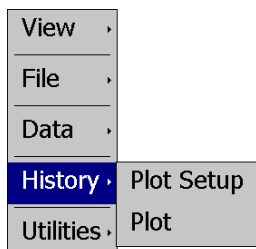

History menu

Plot Setup: Select data file points and time period for history review.

Plot: Plots historical data after time and points are selected.

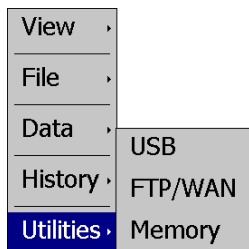

Utilities menu

USB: Allows the user to access file utility functions.

FTP/WAN: Provides access to the automatic file back-up settings.

Memory: Displays memory capacity remaining on the EZT-570S.

7.1 Selecting Points for Logging

In order for the data logging function of the EZT570S to operate, you must first select what variables are to be logged to the data file. To choose which points are to be logged, select “Log Points” from the Data menu. This screen allows the user to select any point(s) from the system for data logging.



Figure 7-1 Assign Log Points

Select the desired items from the list by turning each one on or off. Control loops offer PV, SP and %Out selections while monitor points provide only the process value (PV) selection. When selections are completed, press the “Save” button to save the point selection to memory. New selections will not take effect until the Save button is pressed.

7.2 Start/Stop Data Logging

The EZT-570S logs data to its SD card. Current data for each variable is written to the log at a fixed interval based on the settings entered in the “Length” and “Interval” fields. File names are automatically generated using MMDDYYYY-HHMMSS format (where MM = month, DD= day, YYYY = year, HH = hour, MM = minutes, SS = seconds). To use a specific file name, touch the “File Name” field and enter the desired name (up to 16 characters). When a file name is entered, the file will be saved as FileName_MMDDYYYY-HHMMSS.

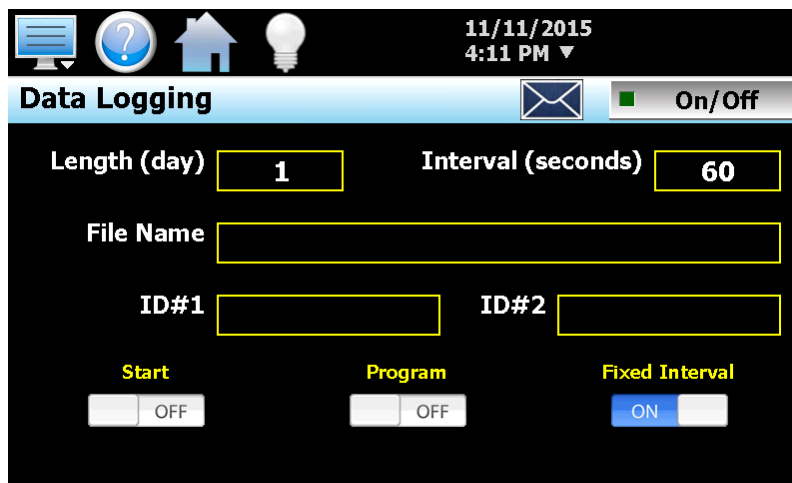

Figure 7-2 Start/Stop Data Logging

The data logger also provides two entry fields, **ID#1** and **ID#2**, which allow the user to enter in information specific to the file such as a batch and/or lot number to identify product that may be associated with the new data file. These entries will be saved with the data log file for later identification.

The ID#1 and ID#2 fields are also used to identify the EZT-570S when DataWeb is active (see section 7.5 FTP/FileWeb/DataWeb Interface). When the DataWeb feature is in use, the ID#1 and/or ID#2 entries are used to identify a specific EZT-570S from many units that may be sending data to the same database. The ID#1 and ID#2 fields also allow the user to search for only the data specific to a single unit in the remote database. The entries in these fields should be unique to each EZT-570S connected to the server.

If more than one EZT-570S utilizes the same entries, the data from all units with the same ID's will be combined under the one ID in the database. This will render the data unusable as there will be no way to split the data between the different units and know which data points are from each unit. If this does occur; however, the EZT-570S will still have a local copy of the data stored to the local data log file(s). This provides a backup copy of the data just in case the ID numbers of more than one unit are identical.

The **Length (days)** field sets the length of a data file in number of days. It can be set for 1 to 31 days. Once the selected number of days has elapsed, a new data file will be created and logging will continue in the new file.

The **Interval (seconds)** field is used to set the rate at which points are written to the log file which equates to the sample rate in seconds. When the "Fixed Interval" option is turned on, the logging interval will be automatically set to record at minute intervals based on the number of days set for the file. If the file is set for 1 day in length, the logging rate will be at 1-minute intervals. If the file is set for 7 days, then the logging rate will be every 7 minutes. This keeps the data file size manageable and able to be viewed by the EZT-570S data viewer.

The log interval can be manually set to any rate between 6 and 1860 seconds in any combination with the number of days before a new file is started. To do this, turn off the "Fixed Interval" option and enter in the desired logging rate in seconds.



Logging at shorter intervals allows the EZT-570s to capture fast changing processes, but the data files can become extremely large. Files that exceed the capability of the data viewer (>520KB in size) will have to be extracted from the EZT-570S using a USB memory stick or FTP file transfer in order to be viewed remotely on a PC.

Files larger than the 520KB limit will not be automatically, digitally signed by the EZT-570S. If the files are to be digitally signed, this must be done manually by extracting the files and using the CSZ data viewer program running on a remote PC.

To manually start data logging, press the "On/Off" button. Any time logging is enabled, the indicator on the button will be illuminated. To stop data logging, press the "On/Off" button again. Data logging can also be started automatically by turning on the "Start" or "Program" option.

The **Start** option automatically turns data logging on whenever the EZT-570S is first powered on. This action simulates that of a standard chart recorder.

The **Program** option is a convenient method for gathering information that pertains only to the operation of an automated ramp/soak program. When selected, the EZT-570S will turn the data logger on at the beginning of a program and off once the program is completed. This eliminates the need to scan through extensive data records to find the specific information you are looking for from a particular time period.



The EZT-570S will automatically use the program name as the filename for the log file. This provides a simple identifier for log files that pertain only to automatic program operation. Any entry made in the File Name field will be ignored.

The send email icon  allows the user to send a copy of the currently opened historical data file to any of the email addresses entered into the system. When the email icon is pressed, an “Add Recipients” window will be displayed where the user can select recipients for the file from any of the email addresses configured under the EZT-570S email settings. For information on how to add email recipients, see the section 5.10, Email.

 *The email utility has a file transfer capacity of 500KB. If the file is too large to be sent using the email utility, it will have to be copied to a USB memory stick using File Utilities or transferred using FTP in order to be viewed remotely on a PC.*

7.2.1 Calculating Log File Size

The EZT-570S saves the log file in a text-based format (.csv), so the amount of memory consumed for each reading is dependent upon the number of digits required to accurately display the value. This optimizes memory usage but also makes calculating an exact file size difficult. To obtain a worst-case approximation of the resultant file size, use the following formula:

$$\text{File Size (KB)} = 1 + [0.023 + (0.006 * \text{number points selected for logging})] * \text{number of readings}$$

7.3 Reviewing Historical Data

Historical files can be opened and viewed using the historical viewer. In order to view a historical data file, it must first be opened by selecting “Open” from the File menu. Once the file has been opened, the EZT-570S will automatically plot up to the first eight channels of the historical data file or the user can choose to cancel the plot select which channels should be plotted as well as adjust the specific time period to plot.

 *The open historical data file list will display up to 650 files. If more than 650 log files are present, the files cannot be shown in the list and the files will have to be exported from the EZT-570S in order to view them. This can be done either via USB file utilities (see section 7.4) or FTP (see section 7.5).*

7.3.1 History Plot Setup

The history plot setup allows the user to select any time frame (zoom in/out) from the historical data file as well as select up to six channels of data to plot. To edit the settings for the historical plot, select “Plot Setup” from the History menu.



Figure 7-3 Plot Channels

Any point from the data file can be selected along with the vertical axis to be used for each channel to be plotted. Select channels from the list by turning them on or off, and use the “Left” and “Right” axis buttons to assign the selected item to the left or right axis for the plot range. To adjust the period of time to plot from the data file, press the “Time” button.

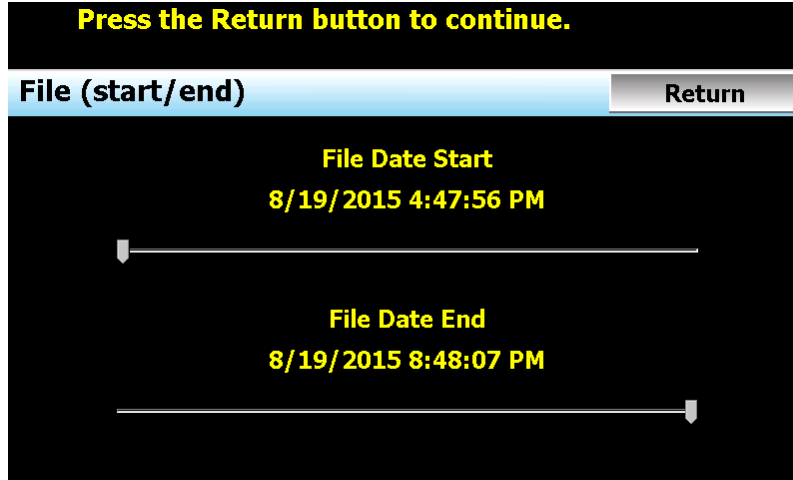

Figure 7-4 Plot Time

The start and end dates for the currently loaded file will be shown with time in hours, minutes and seconds. The “File Date Start” and “File Date End” sliders are used to select a time span for historical viewing. Once the desired start and end times have been set, press the “Return” button to return to the Plot Setup screen.

7.3.2 Plotting Historical Data

To display the data from the currently opened history file select Plot from the History menu. If a file has not been opened or data points have not been assigned to plot, the EZT-570S will alert the user to correct the problem. The ‘X’ and ‘Y’ axis scales are set to auto scale based on current values for each plot channel so no user action is required.

The historical graph provides the same zoom feature as the real-time trends so the user can zoom in on a particular area of the historical plot by dragging their finger across the screen to draw a rectangle around the desired plot area.

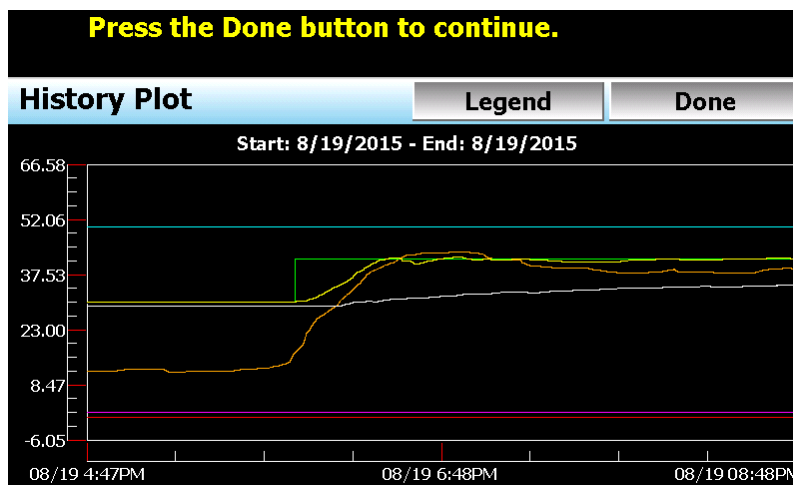

Figure 7-5 Historical Plot

Pressing the “Legend” button will provide the user with channel information by displaying the names of the selected plot channels, which axis they are associated with and the color used to display the plot channel. Pressing the button again will toggle the display back to the historical plot.

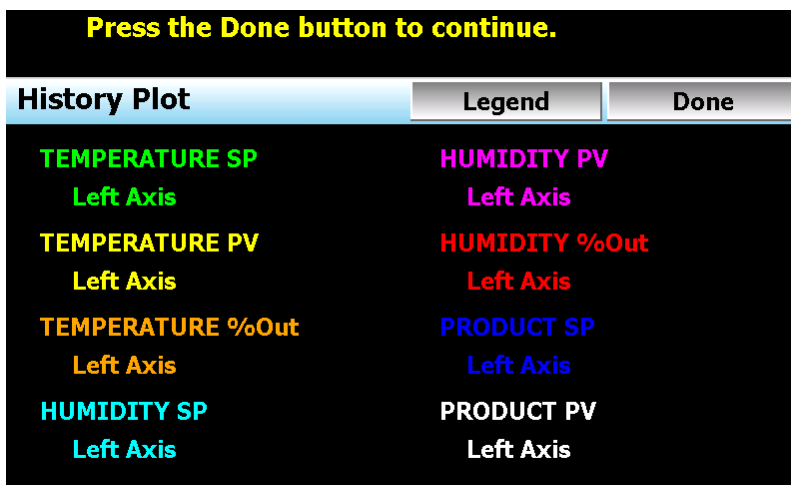

Figure 7-6 Historical Plot Legend

! When pressing the Legend button to toggle between the historical plot and the legend screen, it may take several seconds for the plot to become visible depending on the size of the data file and number of channels selected to plot.

When finished viewing the historical plot, you must press the “Return” button to exit the historical data viewer and return to the main data log screen.

7.4 USB File Transfer

A quick note about file storage; data and setup files (programs, alarm log and audit trail files) need some maintenance every now and then. After a period of time, storage devices fill up and files require backup or file deletion when no longer needed. The “Utilities” section of the EZT-570S provides all the functionality required for maintaining the internal SD memory card. The internal SD card should not be removed from the EZT-570S interface. Any change to SD directory structure (moving or deleting files with a PC) may cause the EZT-570S to stop operating and a new SD card will need to be ordered. Never move or delete the directories unless using the provided file utilities functions.

! The data log files, programs, alarm log and audit trail directories are saved to the internal SD card (not the USB memory stick device) plugged into the EZT-570S. Never unplug the SD card when the ET-570S is powered up or loss of data may result.

The USB file transfer screen allows the user to copy or erase files from the internal SD card. Complete file directories for all file types can be copied to the USB memory stick and erased from the internal SD card. The current status for file functions is displayed for the operator during copy/delete operations. The EZT-570S also allows automatic programs to be imported from the USB memory stick. Programs must be exported from another EZT-570S to the memory stick first, before this function can be used.

! All file transfer functions can be used while data logging is running. If the operator needs to back up or delete files from the system, a large number of files could take considerable time to backup and delete from memory. The file transfer screen will be locked during file transfer so plan the timing appropriately when access to other screen functions is not required. When data logging is running, the current data log file will not be copied or deleted while using the file transfer functions.

This protects the current file and makes sure that the data file is complete before being copied and cannot be deleted from memory while it is still in operation.

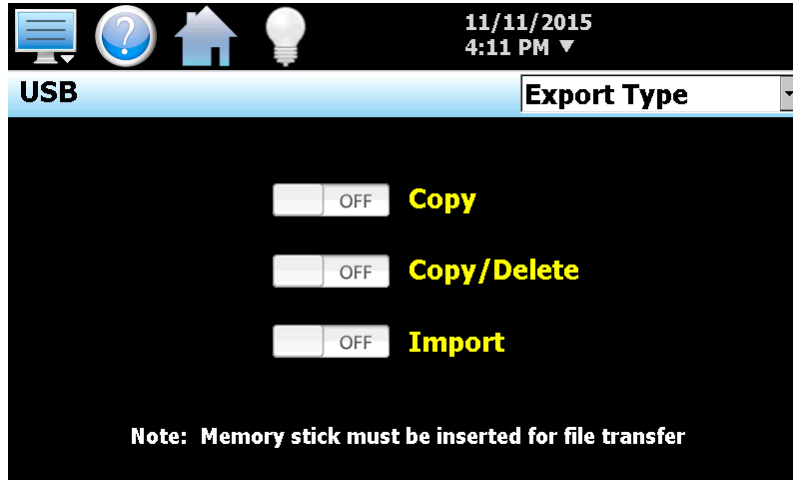

Figure 7-7 USB File Transfer

To **Copy** files, insert the USB memory stick into the USB port. Select the file type you wish to copy from the “Export Type” drop down menu. Available file selections are Program, Alarm, Audit, and Data files. Once the selection is made, press the “Copy” button. All related files will be copied to the USB memory stick with progress status displayed to user.

To **Copy/Delete** files from internal memory, insert the USB memory stick into the USB port. Select the file type you wish to copy and erase from the EZT-570S internal memory, by selecting it from the “Export Type” drop down menu. Available file selections are Program files, Alarm files, Audit trail files and Data files. Once the selection is made, press the “Copy/Delete” button. All related files will be copied to the USB memory stick and then deleted from the EZT-570S with progress status displayed to user.

The **Import** file function allows automatic ramp/soak program files to be copied from the USB memory device to the EZT-570S. A dialog box will appear listing the available program directories on the USB memory stick. Program directory names exported from the EZT-570S are in the format ‘Profiles_mm-dd-yyyy-hh-mm-ss’.

! *The USB memory stick must be inserted into the USB port for any of the file utility operations to function.*

Due to manufacturing variations in the USB memory sticks, it may take from a few seconds up to 30 seconds for the EZT-570S to recognize the device when it is plugged in. Allow sufficient time for the device to be recognized before attempting any file utility operations or the EZT-570S will indicate a file transfer/memory stick error.

When files are being copied to the USB storage device, a directory for each file type will be created to store the copied files. The directory structure is as follows:

Program files directory:	Profiles_mm-dd-yyyy-hh-mm-ss
Alarm files directory:	Alarm Files_mm-dd-yyyy-hh-mm-ss
Audit files directory:	Audit Files_mm-dd-yyyy-hh-mm-ss
Data files directory	Data Files_mm-dd-yyyy-hh-mm-ss

The purpose for using the date and time as part of the directory name, is to make sure the user can track the date and time of the file transfer. If a user transfers a file type more than once in a single day, the files will be grouped logically by time.

When accessing the data files saved to the USB memory stick, the data files will be in “.csv” format. These files can be opened directly with Microsoft Excel or any program that opens a comma separated file format. You can copy or empty the “Data Files” directory by simply plugging the USB device into a PC’s USB port. The device then becomes like any removable disk attached to the computer and can be manipulated once plugged into the PC.

The CSZ Data Viewer program is a free Windows accessory program that allows users to view, plot and print data files and is available from CSZ Products. It is required when using the digital signature feature of the EZT-570S.



Once files are deleted from the EZT-570S storage devices, they are gone and cannot be retrieved. Once again, do not edit, move or delete any other files from the internal SD memory card unless using the EZT-570S file utilities. The EZT-570S may not operate properly if you do so.

7.4.1 Recommended File Maintenance

A quick note about file storage; data and setup files (programs, data files, alarm log and audit trail files) need some maintenance every now and then. After a period of time, storage devices fill up and files require backup or file deletion when no longer needed. The Microsoft WinCE platform allows for a maximum of 999 files per directory when all the files begin with the same 8 characters. Alarm and audit files are recorded by date (one per day) with the format of MMDDYYYY (where MM = month, DD = day, YYYY = year) so there is essentially no limit to the number of files other than available storage area.

Data log files however, could reach the maximum based on the number of files created per day and if the logging on Program is enabled or a file name is specified by the user. If data logging is manually started or activated on system Startup and only 1 file is created per day, there will be no effective file limit since the first 8 characters of the file name are the date, like that of alarm and audit files.

If a file name is specified or logging on Program operation is enabled, each file will begin with the same prefix. Thus, multiple files can begin with the same 8 characters this limiting the maximum number of files that can be stored. At a frequency of 3 per day, 7 days a week for example, the maximum 999 files would be reached within one year. It is recommended that a quarterly maintenance schedule be adopted to copy and delete all data files from the EZT-570S through either the USB file transfer or FTP backup utilities to prevent the maximum file number from being reached.

If the maximum number of files is reached, the EZT-570S will display the alarm message “Data file error. SD card full or missing.” and data logging will be disabled. Note that there is still sufficient memory space on the SD card; however, due to the maximum number of files being reached, no more files can be placed in the data log folder. Regular backup and removal of files from the EZT-570S will prevent this from occurring.

It is also highly recommended to backup and delete alarm and audit files as well. While it is possible to store years of files, the time it will take to copy the files once the time has come, could take hours due to the large number of files. The EZT-570S file browser is also limited to a total of 650 files. If the number of alarm files or audit files exceeds the 650-file limit, you will be unable to open and view alarm or audit files on the EZT-570S. They will have to be exported via USB or FTP in order to be viewed.

More frequent backups will also require less time to perform. The speed at which files can be transferred is more dependent on the number of files than the size of the files. A fewer number of large files takes less time than a large number of small files.

7.5 FTP Data Backup

The FTP/WAN screen allows the user to configure automatic back-up of all data files contained in the EZT-570S memory to a user designated FTP or secure FileWeb site (https://). When enabled, the EZT-570S will automatically back up all data log files, alarm files and audit trail files at 2:00AM each day. With the optional delete files selection, the EZT-570S will then automatically delete the files from its internal memory after back up. This will maintain EZT-570S memory automatically, so that continuous data logging can be performed without filling up the available memory space.

The EZT-570S also offers a DataWeb LAN/WAN/Cloud interface. This allows the EZT-570S to transfer data directly into a server's data base rather than using file-based data solutions. The DataWeb interface provides the transfer of secure (https://), real time data which can be shared and viewed across networks for real time manufacturing data systems interface.

 *Setting up an FTP site on your network may require authorization and/or assistance from your network administrator. Contact your network administrator for proper settings and authorization from your network server (if required) to allow the EZT-570S to connect to the designated FTP site.*

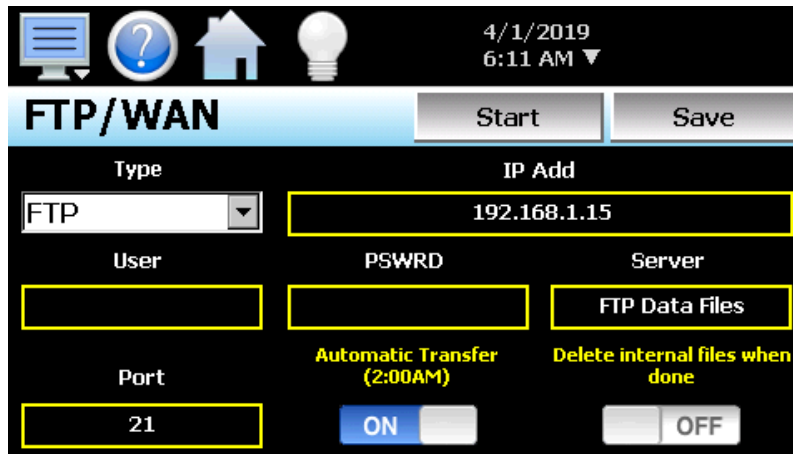

Figure 7-8 FTP/WAN Setup

The **Type** drop down is used to select the FTP/WAN interface. Choices are FTP, FileWeb and DataWeb.

The **IP Add** field is used to enter the IP address of the FTP/FileWeb/DataWeb site that EZT-570S is to interface with.

The **User** field allows you to enter a user name for site access. When the EZT-570S connects to the FTP/FileWeb/DataWeb site, the user name will be used to identify the connection. If a security login is required (FileWeb/DataWeb always require security credentials), the proper user name will have to be entered in this field. If security is not used (FTP only), this field can be left blank (blank for anonymous login using FTP only).

The **PSWRD** (password) field is used in conjunction with the user name field and is for entering a password so the EZT-570S can access the site. If security is not used (FTP only), this field can be left blank (blank for anonymous login using FTP only).

The **Server** field is used to enter the directory information where the files are to be backed during FTP/FileWeb operation. This field is not used during DataWeb interface selection. When the connection occurs, the EZT-570S will place the historical data files in the "Sever" field directory structure when using FTP/FileWeb interfaces. The EZT-570S will automatically create an "Alarms" directory and an "Audit"

directory within the specified server directory for backup of the alarm files and audit trail files. The “Server” field for FTP and FileWeb must match the directory structure setup at the server.

For example, if FTP is used and the “root” path at the server is “Files”, in order for the EZT-570S files to be transferred to this directory, the “Server” field must contain the text “Files”. If there is a directory inside of the server root “Files” directory named “unit1775” and the files are to be transferred to this directory, the “Server” field must contain the text “Files/unit1775”. The FTP operation will error and the transfer will not be completed if the “Server” field is not entered properly or does not match the FTP server configuration.

- ! *For FileWeb operation, the Server field is optional and can be left blank. It can be used to enter additional directory information (if desired) on where the files are to be stored. By default, the EZT-570S is hard coded to store files on the specified server in the “\Files\user name\” directory. If an entry is made in the Server field, the resulting path would be “\Files\user name\server\”.*

When the **Automatic Transfer (2:00AM)** option is turned on, the EZT-570S will perform an automatic backup of all historical data files, alarm files and audit trail files contained in its internal memory to the designated FTP/FileWeb site. Note that if data logging is currently active, the active file will not be copied. When the **DataWeb** interface is used, real time data is transferred to a database rather than transferring actual files so this option is not used and is disabled.

- ! *If the barcode reader option is enabled and set for “Start the automatic program”, the automatic transfer will be skipped if it occurs while a program has been selected through the barcode reader but has not yet been started by the user. See section 5.9 Barcode Reader for more information.*

When the **Delete internal files when done** option is turned on, the EZT-570S will delete all data log files, alarm files and audit trail files within its memory after completing the backup to the FTP site. Note that if data logging is currently active, the active file will not be deleted. When the DataWeb interface is used, real time data is transferred to a database rather than transferring actual files so this option is not used and is disabled.

Once all settings have been made, press the “Save” button to save the settings so that on the next power-up, the entries will be maintained. The “Start” button can be used at any time to perform a manual data backup using FTP or FileWeb interfaces. If the files already exist on the FTP/FileWeb site, they will be overwritten on each subsequent backup. If the FTP/FileWeb site is down, or the EZT-570S is not connected to the network, a local alarm message on the Alarm screen will indicate a transmission failure.

- ! *Typically, FTP/FileWeb server connections use case sensitive alpha-numeric characters for the User name, Password and Server directory. Contact your network administrator for proper settings.*

7.5.1 More About FTP, FileWeb and DataWeb Interfaces

FTP servers (File Transfer Protocol) have been around for many years and can be installed on local or network machines. The FTP server allows a client (EZT-570S) to transfer files to the FTP server once installed. This allows for manual and automatic backup of data from the EZT-570S.

EZT-570S Field Setup	FTP Server Setup
Type = FTP	FTP server setup for passive operation (see Appendix section FTP, FileWeb, DataWeb Requirements/Installation for additional information).
IP Add = xxx.xxx.xxx.xxx	Actual IP address of FTP server
User = userName	Actual user name for login if authentication used.
Password = userPassword	Actual password for login if authentication used.
Server = myFTP	FTP server setup with a root directory named "myFTP". The FTP server directory path must exist and match the EZT-570S setup for proper operation. If there is an additional directory within the "myFTP" root directory, its name would be appended to the path. (i.e. myFTP/Files if a "Files" directory inside the myFTP server root directory is the target for transfer).
Port = 21	Port used at EZT-570S and open at FTP server.



Make sure proper permissions are set at the FTP server for access/creation of directories and read/write access. Also check root directory structure at Server to identify the actual root that was created for the files since there can be additional layers created by the server and displayed in the path.

The FileWeb interface allows the EZT-570S to transfer its files to a web site for download which can then be viewed using a standard web browser. This interface provides the user the ability to setup a web site to store files for local or global access without installing an FTP server. The EZT-570S supports https:// (secure) transfer of files.

EZT-570S Field Setup	FileWeb Server Setup
Type = FileWeb	FileWeb server setup (see Appendix section FTP, FileWeb, DataWeb Requirements/Installation for additional information).
IP Add = https://cszutil.com/FDDataService.svc	Actual named address of FileWeb server/service.
User = userName	Actual user name for login at FileWeb server (required).
Password = userPassword	Actual password for login at FileWeb server (required).
Server = <i>optional path</i>	The FileWeb server/service must be configured with a root "files" directory in order to use the EZT-570S FileWeb feature. The EZT-570S is hard coded to transfer files to the "files" directory in the root of the server. If the Server field also contains an entry (i.e. optionalPath), the resulting path would be "files\optionalPath". If the directory does not exist, it will be created at the server by the EZT-570S based on the permissions settings at the server.
Port = not used	



Make sure proper permissions are set at the FileWeb server for access/creation of directories and read/write access. Also check root directory structure at Server to identify the actual root that was created for the files since there can be additional layers created by the server and displayed in the path.

The DataWeb interface allows the EZT-570S to transfer data to a web data base service using MySQL and Microsoft IIS as a web platform. The EZT-570S can interface directly to a local or Web data base (Cloud) thereby allowing access to any system globally without any special “client” applications required to view the data. This allows the EZT-570S to share data with local or global manufacturing systems by storing data directly to a manufacturing database. The EZT-570S supports https:// (secure) transfer of data.

EZT-570S Field Setup	DataWeb Server Setup
Type = DataWeb	FileWeb server setup (see Appendix section FTP, FileWeb, DataWeb Requirements/Installation for additional information).
IP Add = https://cszutil.com/FDDataService.svc	Actual named address of DataWeb server/service.
User = userName	Actual user name for login at FileWeb server (required). This is the directory where the database structure will reside on the server. The EZT-570S will use this directory path for sending data to the database.
Password = userPassword	Actual password for login at DataWeb server (required).
Server = not used	The directory where the database exists uses the userName as the default location for data storage.
Port = not used	
Data logging screen entries: ID#1 = unit specific identifier ID#2 = unit specific identifier (see section 7.2 Starting/Stopping Logging)	Used as the unit identifiers by the remote database in order to store the data sent from the EZT-570S. At least one field must contain an entry and should be unique to any other EZT-570S that connects to the same server database.



An IT professional with experience is required for DataWeb server setup. Cincinnati Sub Zero does not support server-side programming or setup but can offer 3rd party resources to assist with or handle complete server-side projects.

The DataWeb interface does not transfer complete files for backup like the FTP and FileWeb interfaces. The DataWeb interface transfers records in real time based on the log setup interval at the EZT-570S. When logging is started at the EZT-570S, data will begin transfer to the server-side site. Data will be transferred to the server at the beginning of logging (one record) with additional records transferred based on the rate that the EZT-570S data log interval is set for.

If the data log interval rate is set for 60 seconds, the EZT-570S will populate the database with a single set of records (PV, SP, %Out determined by data log/server setup) once every 60 seconds. If the data log interval rate is set for 120 seconds, the EZT-570S will populate the database with a single set of records (PV, SP, %Out determined by data log/server setup) once every 120 seconds. Data log intervals can be set as fast as 6 seconds since buffering is used at the EZT-570S for faster data log rates, but in this case the database would receive a total of 10 records once per minute (one record per 6 seconds). Buffering for rates faster than 1 minute is used to reduce access/overhead at the server side while still maintaining 6 second date/time stamps for database record keeping.

7.5.2 FileWeb/DataWeb Server Components and Requirements.

While the actual server-side development is more involved than this manual will cover, component overview and installation is covered in section A.1 of the Appendix.

Web Development Support:

Cincinnati Sub Zero does not support or develop custom server-side web solutions. We can offer 3rd party resources to assist customers in these development requirements.

7.6 CSZutil.com Web site for FTP, FileWeb and DataWeb Testing

The CSZutil web site is a 3rd party partner's http/https site that allows customers to create a free account and test the FTP, FileWeb and DataWeb interfaces offered on the EZT-570S. The site automatically deletes files every hour since this is a test site only and cannot be used for permanent web storage of files or data. The site allows customers to fully test and verify that data is being transferred properly from the EZT-570S device to the CSZutil site, thereby providing everything needed to test the EZT-570S and the Internet connection without requiring additional software or development. This allows the customer to test the interface and pick which type of data transfer is the best for operations.

Access the Web Site and Create an Account:

To create a free account, go to the following link: <https://CSZutil.com/FDDataWeb/>

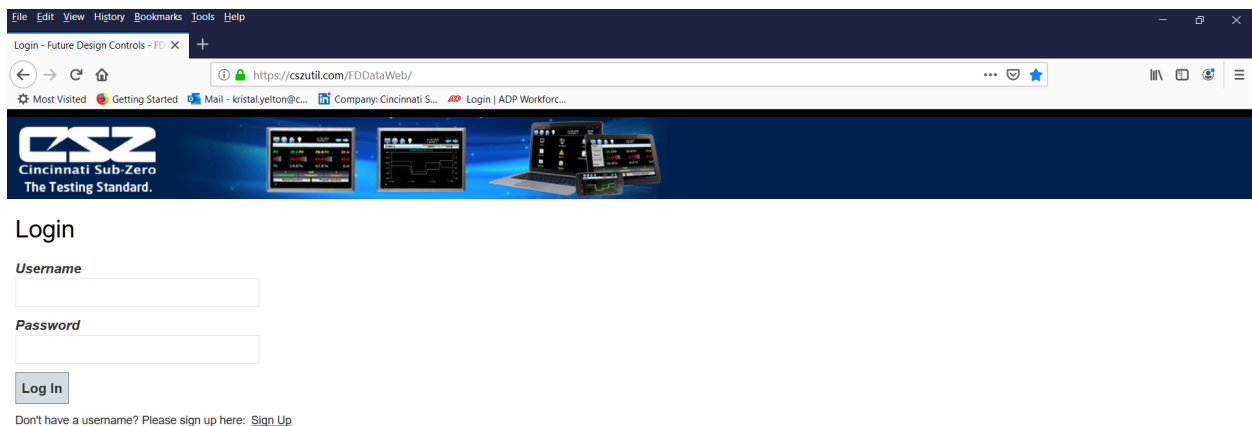

Click on the “Sign Up” link. Enter your name, company name, email address and password. Note that your email address will not be used for solicitation purposes. It is used to send an account verification email. The email sent requires no confirming information; it only verifies that a real user got the email before activating the account. Although CSZutil.com is a no-charge site, important user data is encrypted for additional protection.

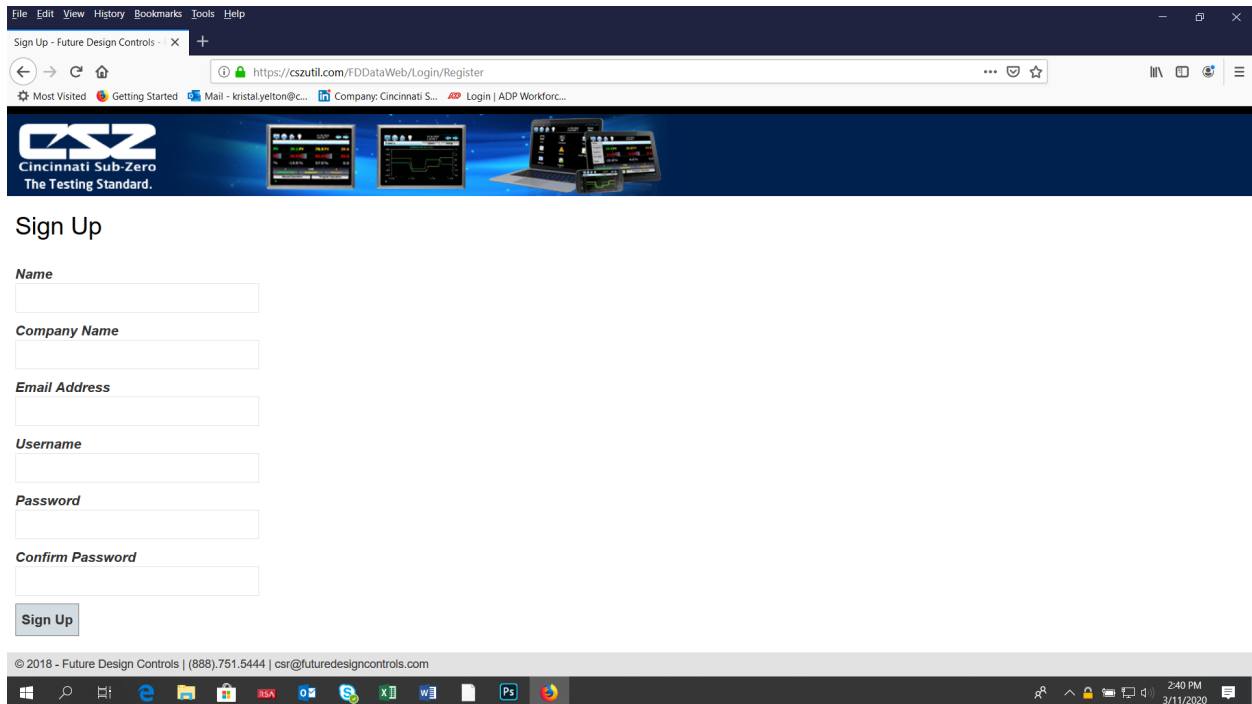

Once you have created and verified your account, you can log in to the website. Once logged in, the main CSZutil website will be displayed with tabs for Data (DataWeb), Files (FileWeb), FTP Files (FTP) and Configurations. These tabs can be clicked on and will display data after transfer from the EZT-570S. Every hour, the data will be deleted from each section (except for Configurations) or the data can be manually deleted using the “Delete” link on each page.

Data Files Page (FileWeb):

The data files page, accessible from the “Files” menu item, lists the files in the customer’s data directory. These are only the files in the customer’s directory, not all uploads. The user can delete the files from this page.

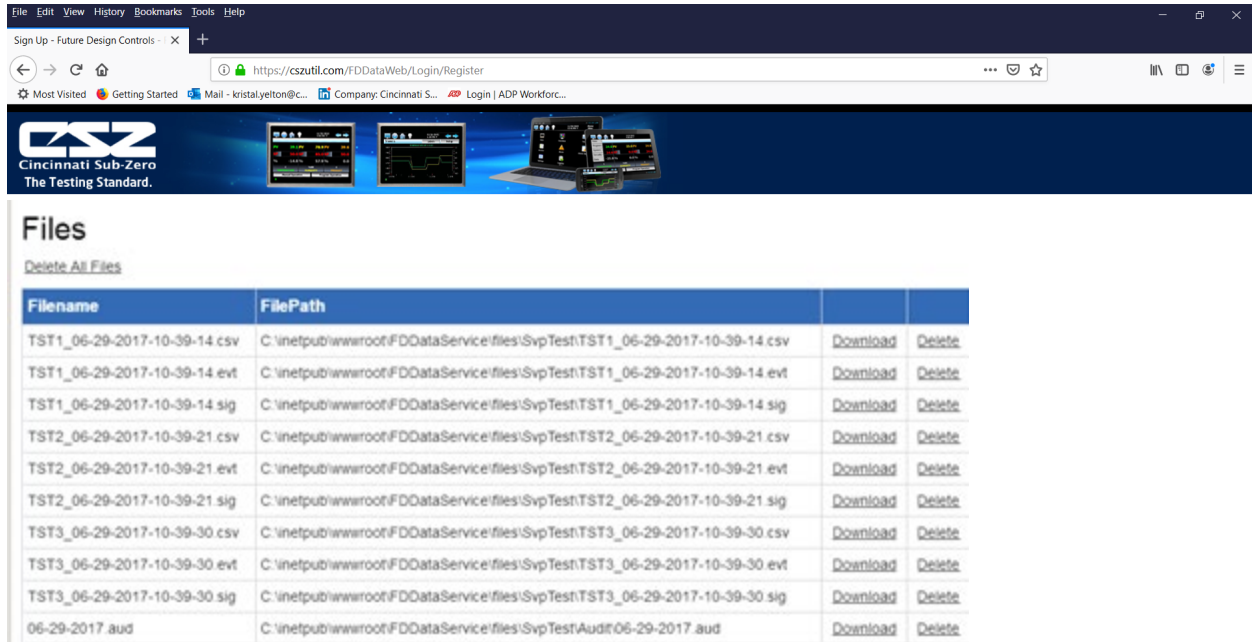

FileWeb sample setup using CSZutil.com:

To setup the EZT-570S for use with the CSZutil.com FileWeb server, go to the FTP/WAN screen on the EZT-570S and enter the following data into the screen fields. Make sure to replace the “custName” and “custPassword” text below with the actual user name/password entered during the CSZutil.com signup process.

- Type = FileWeb
- IP Add = https://CSZutil.com/FDDataService.svc
- User = custName
- Password = custPassword
- Server = optional
- Port = not used

Press the “Save” button to complete the setup on the EZT-570S FTP/WAN screen. Press the “Start” button to begin a manual transfer of files from the EZT-570S to the CSZutil.com site. Login to the CSZutil.com site to view the FTP files by pressing on the Files link on the page (or press Files link if already logged into CSZutil.com).

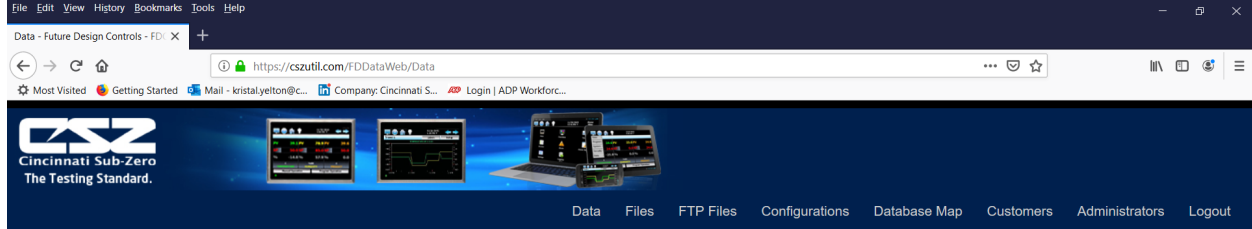

Database Data Page (DataWeb):

Once logged in, the customer will be shown the Data page. If data has been uploaded to the database, the “Device ID” drop-down menu will contain the list of units (according to the ID#1 and/or ID#2 entries as made on the Data logging screen).



Data Table

Search Device IDs:

Device ID: Start Date: 02/29/2012 12:35:52 End Date: 02/29/2012 15:48:28 Data Range Column: Low Data Range: High Data Range:  

Delete Device Data:

To view the data, select the desired unit from the list and click the “Get Data” button below the Device ID menu. The data available between the Start Date and End Date will be displayed.

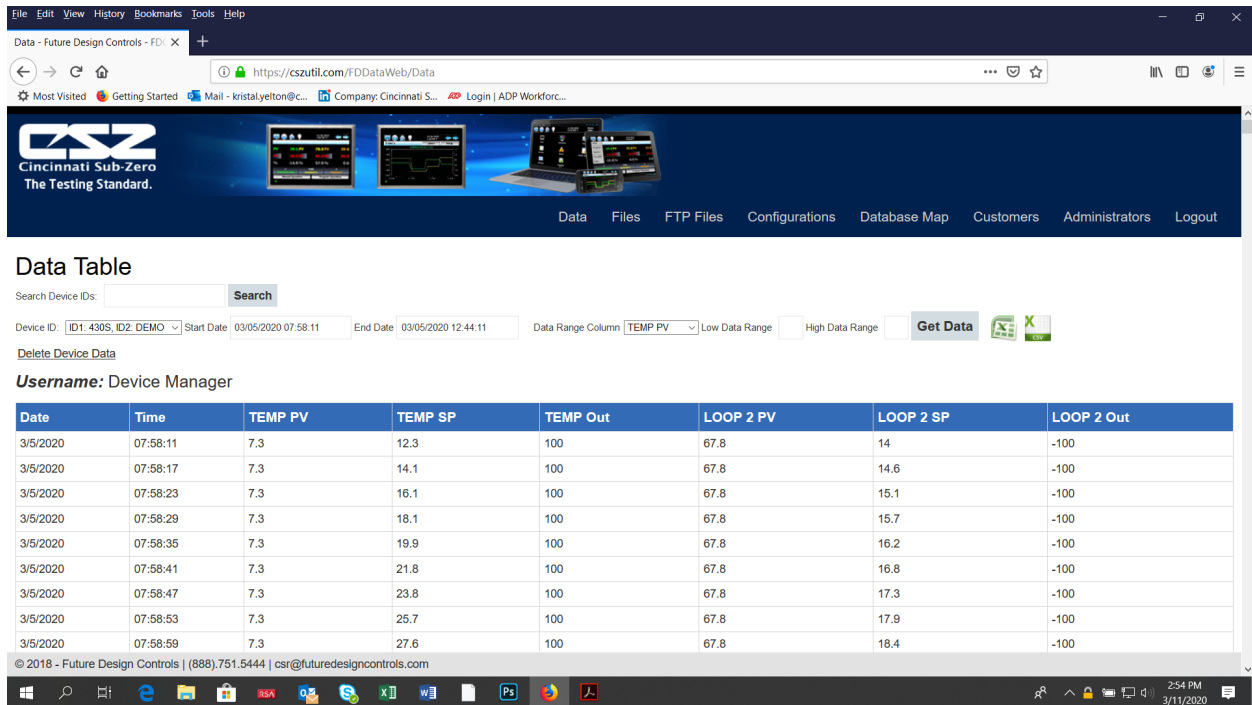

The start and end dates can be altered by simply clicking on the fields to display only data from a specific time frame. When the specified time period is entered, press the Get Data button to refresh the data table.

The Data Range Column selection and Low/High Data Range fields can also be used to search for data points that fit within the specified range.

The available data can also be viewed in graph format. Hover the mouse over the Data tab and selections for Trend and Table will be provided.

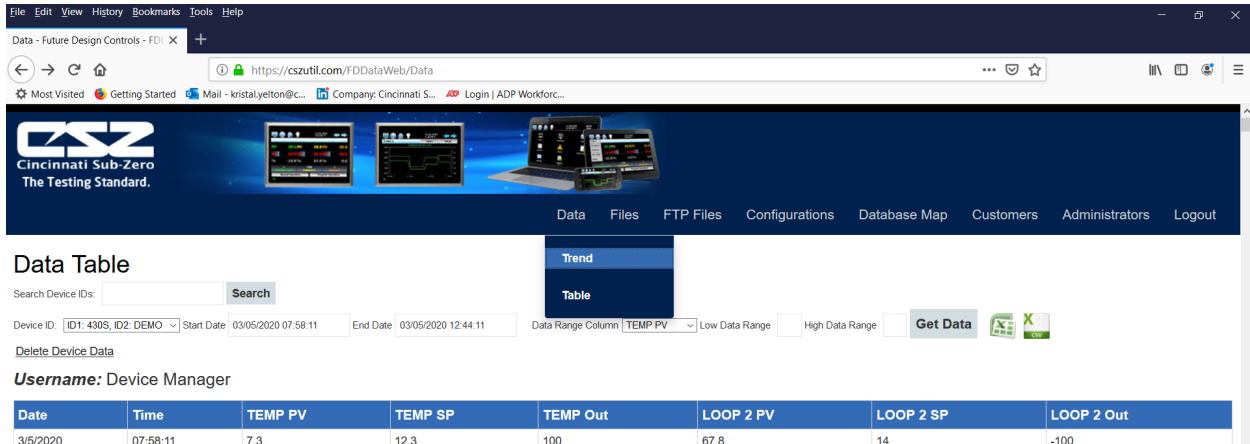

Once Trend is selected, choose the desired unit from the Device ID menu. Place a check next to each available point you want to plot and click the Update Chart button. A trend plot according to the chosen plot points and time range will be displayed along with the corresponding data table below.

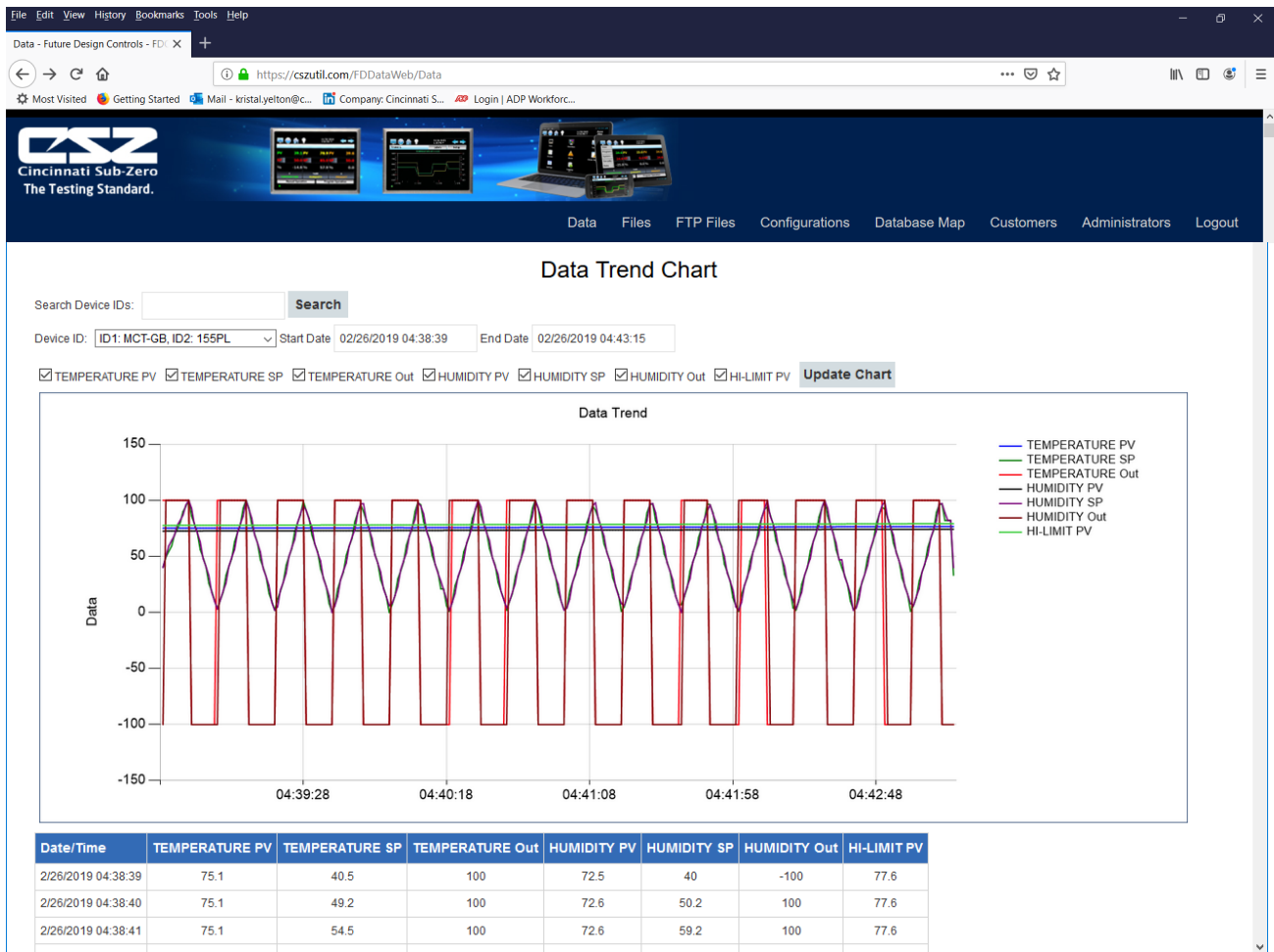

Once you access the Data Table or Data Trend Chart page, the default start and end times are based on the available data at the server. If an EZT-570S is actively sending data, you must manually set the end time to a future date so that each time you refresh the page via the Get Data or Update Chart buttons, the page is updated with the latest data sent from the EZT-570S.

DataWeb sample setup using CSZutil.com:

To setup the EZT-570S for use with the CSZutil.com DataWeb server, go to the FTP/WAN screen on the EZT-570S and enter the following data into the screen fields. Make sure to replace the “custName” and “custPassword” text below with the actual user name/password entered during the CSZutil.com signup process.

- Type = DataWeb
- IP Add = https://CSZutil.com/FDDataService.svc
- User = custName
- Password = custPassword
- Server = empty (no characters)
- Port = not used
- ID#1 = unique identifier of your choice
- ID#2 = unique identifier of your choice

Press the “Save” button to complete the setup on the EZT-570S FTP/WAN screen. Next, navigate to the Data logging screen. Make entries in the ID#1 and/or ID#2 fields. These entries should be unique to the EZT-570S and not duplicates of any other EZT-570S you may have connected to the site. Once logging is started at the EZT-570S, data will begin transfer to the “Data” section of the server-side site. Data will be transferred to the server at the beginning of logging (one record) with additional records transferred based on the rate that the EZT-570S data log interval is set for.

If the data log interval rate is set for 60 seconds, the EZT-570S will populate the database with a single set of records (PV, SP, %Out determined by data log/server setup) once every 60 seconds. If the data log interval rate is set for 120 seconds, the EZT-570S will populate the database with a single set of records (PV, SP, %Out determined by data log/server setup) once every 120 seconds. Data log intervals can be set as fast as 6-seconds since buffering is used at the EZT-570S for faster data log rates, but in this case the database would receive a total of 10 records in 1 minute (one record per 6 seconds). Buffering for rates faster than 1 minute is used to reduce access/overhead at the server side while still maintaining 6 second date/time stamps for database record keeping.

7.7 Annotation

The Annotation screen allows the user to add a message to the running data file and view any messages currently associated with a loaded historical data file.

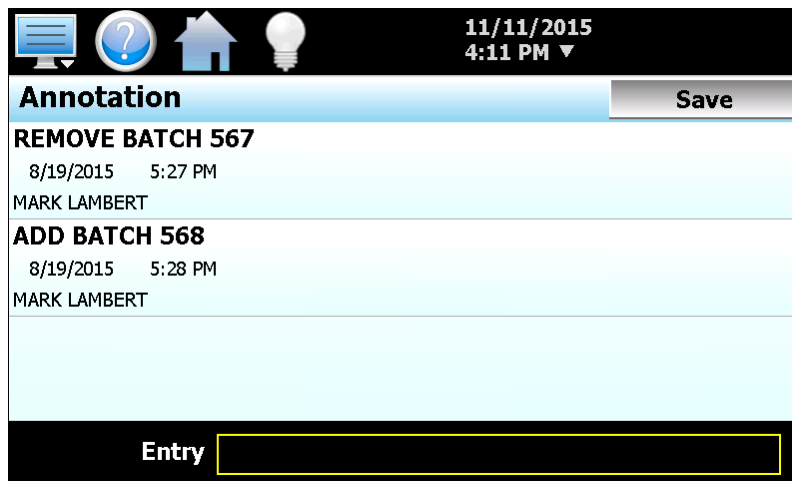

Figure 7-9 Annotation

When a historical data file is loaded, the Annotation screen will display any messages that were written to the file. The date, time, user name and description of the data file annotation is shown. Note that the currently running data log file can be opened as a historical data file, and the current annotations for the running file will be shown.

To add an annotation to the running log file, touch the “Entry” field at the bottom of the screen and enter the message (up to 16 characters maximum). Press the “Save” button and the message will be added to the current log file. If the running log file was opened as the historical log file, the annotation will be shown immediately on the screen as it is added. If logging is not currently running, the entry field will be disabled.

7.8 Digital Signatures

The Signature screen allows the user to add digital signatures to historical data log files and view any digital signatures currently associated with the loaded historical log file.

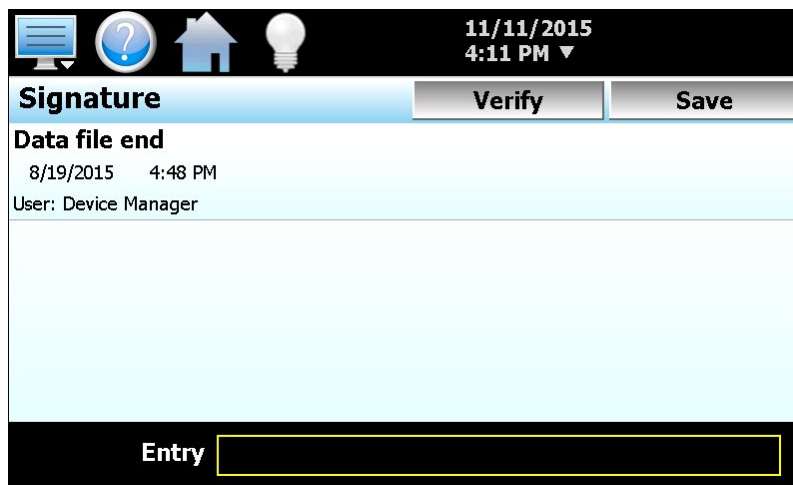

Figure 7-10 Digital Signatures

When a historical data file is loaded, the Signature screen will display any signatures currently associated with the file. To verify a digital signature and ensure that the data file has not been altered, touch the signature in the list box and press the “Verify” button. The EZT-570S will compare the signature to the log file to see if any alterations to the data have been made. The EZT-570S will then indicate if the signature is valid or not.

If the signature is valid, the historical data file is intact and has not been altered. If the signature is invalid, the data has been altered at some time after the signature was assigned to the file. For data integrity, the EZT-570S automatically signs a data file when logging is stopped; however, this only occurs if the “Auto Interval” is selected on the Log screen. If a different logging interval is used, and the file size becomes greater than 500KB, the EZT-570S will not automatically sign the file, and it must be signed by a user.

To add a digital signature to the historical log file, touch the “Entry” field at the bottom of the screen and enter in the comment line for the signature (up to 16 characters maximum). Press the “Save” button and the signature will be added to the log file. The signature includes the date and time of the signature, the user name and comment line. If a user is not logged into the system, the default user name “Device Manager” will be used as the user.

! *The Signature screen is not available if security is disabled. The EZT-570S security module must be enabled in order to digitally sign data log files. See Section 6, Security.*

8. Offline

The offline setup options are available from the System/Settings menu. Prior to entering offline setup, ramp/soak program operation and data logging must be manually stopped. When in offline mode, all EZT-570S digital and analog outputs will be turned off.

The offline menu provides navigation to the following functions:

View	Settings
Setup	Service Counters
Hardware	Service Options
Calibrate	
System	

View menu

Settings: Navigation back to the online settings menu.
 Service Counters: View output operational data (cycles, hours on).
 Service Options: Settings for viewing service data/notifications.

View	
Setup	Units
Hardware	Clock
Calibrate	Language
System	Special

Set menu

Units: Setting for temperature units.
 Clock: Settings for system date and time
 Language: Settings for menu and help language text.
 Special: Settings for custom functions.

View	
Setup	
Hardware	Analog Input
Hardware	Analog Output
Calibrate	Digital Input
System	Digital Output

Hardware menu

Analog Input: Settings for optional analog input operation.
 Analog Output: Settings for optional analog output operation.
 Digital Input: Settings for optional digital input operation.
 Digital Output: Settings for optional digital output (customer event) operation.

View	
Setup	
Hardware	
Calibrate	Offset
System	

Calibrate menu

Offset: Settings for optional monitor offset calibration.

View	
Setup	
Hardware	Display
Hardware	Configuration
Calibrate	About
System	Exit

System menu

Display: Access to display calibration and backlight settings.
 Configuration: Access to EZT-570S import/export utility.
 About: View current firmware/software version numbers.
 Exit: Exit EZT-570S application and access to the configurator.

8.1 Service

The service counters provide service interval alerts and life total service numbers for chamber components and systems. The service intervals are preset at the recommended period for system performance and reliability; however, the values can be adjusted to meet user specific maintenance intervals. When a component exceeds its service interval, a notification alarm can be generated. This alert will notify the operator that service should be performed at the next available down period.

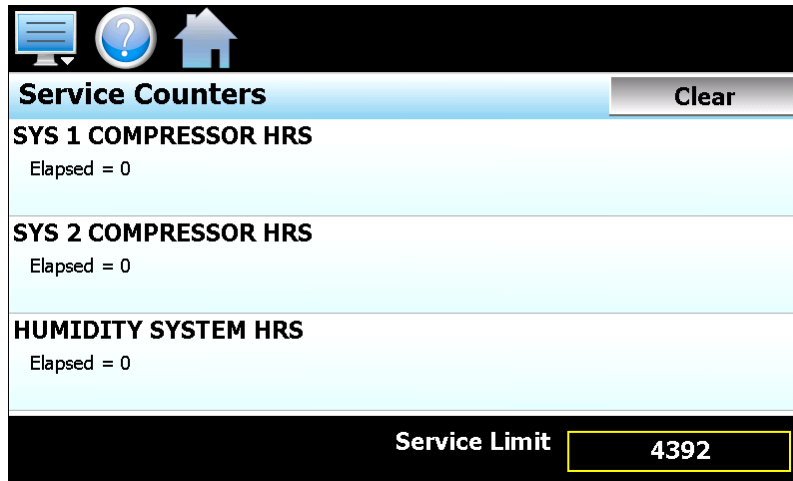

Figure 8-1 Service Monitors

To adjust a counter set point, select the desired item from the list by touching its description. The current set point for the selection will be shown in the service limit field at the bottom of the screen. Enter the new set point by touching the service limit field and press the 'Done' button on the numeric keypad when finished.

! *To adjust the service interval counters, you must be viewing the elapsed service count. See section 8.1.1 Service Options for information on viewing elapsed service and life totals.*

When a service interval is exceeded, an alert can be set to illuminate the corresponding indicator on the status Monitor screen. An audible alert can also be turned on to get the operator's attention. In order to clear the service alert, the elapsed service counter must be cleared.

In order to determine which service counter has been elapsed, scan the list of outputs and look for the 'Exceeded' description. To clear the counter, select the output from the list and press the 'Clear' button. This will clear the counter so that it can begin totalizing for the next service interval.

The service monitor screen can be set to display the elapsed service interval or the life total for the component based on the selection made on the Service Option screen. The alert method can also be disabled if this feature is not desired.

8.1.1 Service Options

The service display options as well as alert action can be adjusted from the 'Service Options' screen.

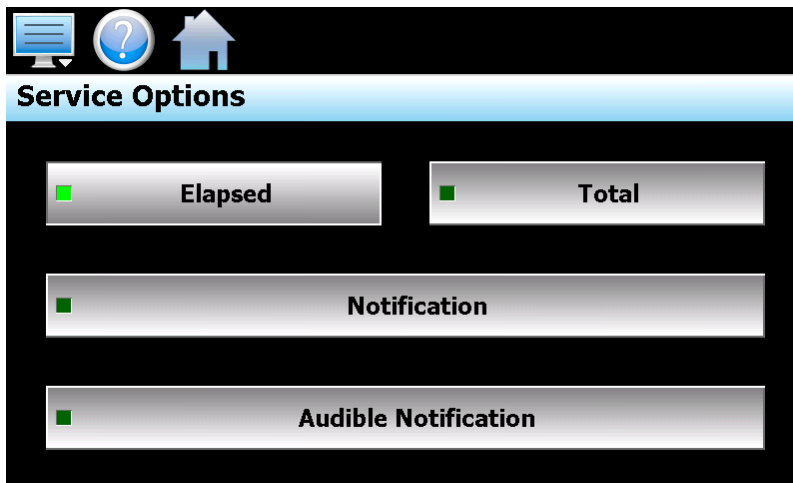

Figure 8-2 Service Options

The **Elapsed** and **Total** buttons are used to select which count is to be viewing on the service screen. The selections are mutually exclusive, i.e., selecting one will automatically deselect the other.

The **Notification** and **Audible Notification** buttons are used to select the alert method when a system or component exceeds its elapsed service interval. The selections are mutually exclusive. The notification selection provides visual notification only, by simply turning on the service indicator on the Status monitor screen. The audible notification selection will also sound an intermittent beep of the chamber's audible alarm. The user will have to then press the Reset button on either the Status monitor or Alarm screen to silence the alarm.

To disable notification, press the button for the active selection to turn it off. When the indicator is off on both notification selection buttons, no service alert will be indicated. Service alerts are disabled by default. For information regarding the service monitors and what they mean, see Section 10, Diagnostics.

8.2 Degrees C\F Selection

The EZT-570S can display temperatures in either degrees C or F. To change the temperature units, select "Units" from the offline "Setup" menu.

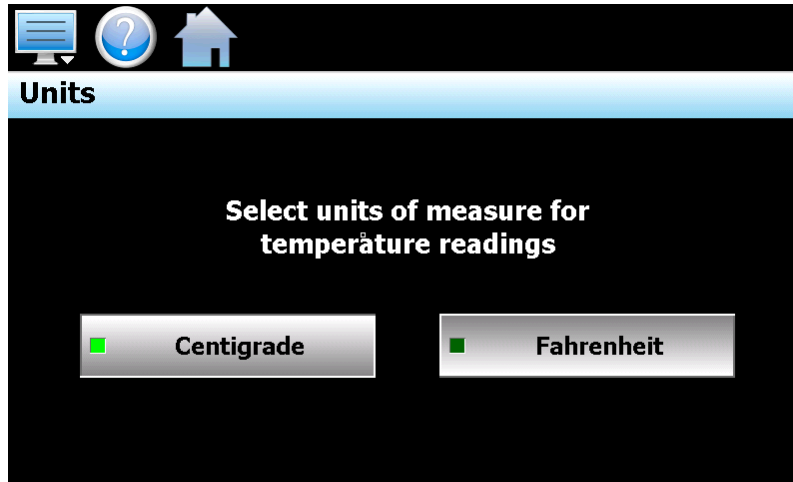

Figure 8-3 Temperature Units Selection

Press the button for the desired temperature units to make the selection. The choices are mutually exclusive so when one selection is made, the other will be de-selected.



When changing display units, ramp/soak program set points will not be converted between units. Separate programs are required for each temperature range. The chamber and/or product under test may be damaged as a result of operating programs that have been written using alternate temperature units.

8.3 Clock Settings

The system date and time is adjusted from the “Adjust” time tab under the Setup/Clock menu. The current date and time will be displayed in the thumb wheels as shown below.

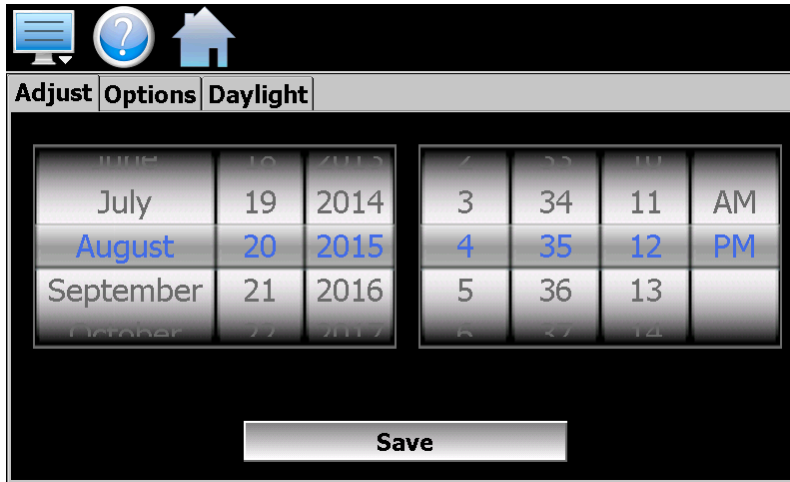

Figure 8-4 Adjust Time

To make adjustments, scroll each time wheel to adjust the month, day, year, hour, minutes, seconds and AM/PM selection. Once all adjustments have been made, press the “Save” button to set the system clock to the date and time entered.

8.3.1 Time Options

Select the time “Options” tab to configure the time zone and national time server clock settings. If the EZT-570S is connected to the internet, these settings can be used to have its clock automatically synchronize the time with one of the nationally provided time servers.

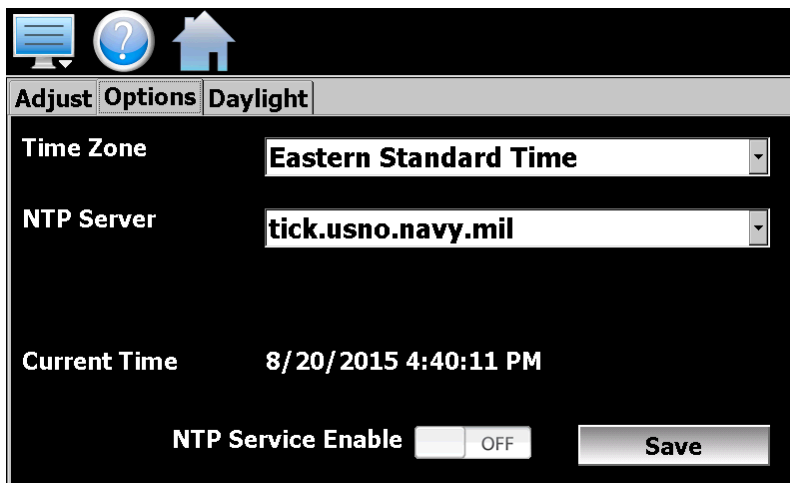

Figure 8-5 Time Options

To enable the national time server, select your time zone and which time server you wish to use from the drop-down menu selections. Turn on the “NTP Service Enabled” option and press the “Save” button. The EZT-570S will then synchronize its time with the selected national time server at 2:00AM each day.

If the EZT-570S is not connected to the internet, a local alarm message will be shown on the alarm screen; “NTP Failure. Check cable and server”, to indicate that the time server could not be located.

8.3.1.1 Local Time Server Settings

If an active internet connection is not available, or company policy prohibits internet access, the EZT-570S can be configured to use a local time server instead of one of the national time servers. To configure the use of a local time server, select “local” from the NTP server list. When selected, the “Name/IP” entry field will be shown. The computer name or IP address of the computer running the local timer server on the LAN can then be entered. The EZT-570S will then contact the local computer in order to synchronize time.

! *The steps required to configure and provide NTP service from a computer on the LAN is outside the scope of this manual. Contact your network administrator for assistance.*

8.3.2 DST Settings

Select the “Daylight” tab to configure daylight saving time options. The daylight savings time options allow the user to set the start date and end date for daylight savings time.

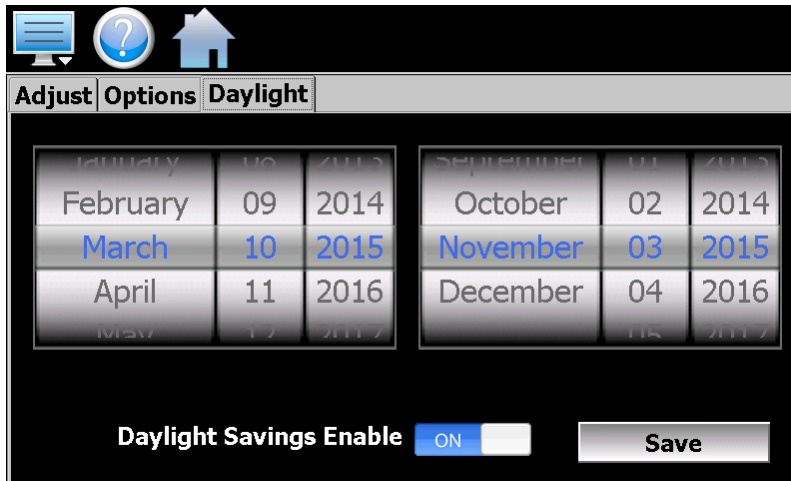

Figure 8-6 Daylight Savings

If your locale utilizes daylight savings time, set the start and stop dates for daylight savings and turn on the “Daylight Savings Enable” option. Press the “Save” button to store the settings. The EZT-570S will then automatically update its clock for daylight savings time.

! *If the NTP time server setting is enabled, and the selected time zone uses daylight savings time, daylight savings must be properly configured and enabled or the clock will not show the correct time.*

8.4 Language

The Language screen is used to select the language for all of the online help, menus and most static display fields. The keypad will remain in English, so all user text entry will still be in English.



Figure 8-7 Language

Available language selections include:

- ✓ Afrikaans
- ✓ Albanian
- ✓ Arabic
- ✓ Basque
- ✓ Belarusian
- ✓ Simplified Chinese
- ✓ Traditional Chinese
- ✓ Czech
- ✓ Danish
- ✓ Dutch
- ✓ English
- ✓ Finnish
- ✓ French
- ✓ German
- ✓ Greek
- ✓ Hebrew
- ✓ Hungarian
- ✓ Icelandic
- ✓ Italian
- ✓ Japanese
- ✓ Korean
- ✓ Norwegian
- ✓ Polish
- ✓ Portuguese
- ✓ Russian
- ✓ Spanish
- ✓ Swedish
- ✓ Turkish

DISCLAIMER: English is the default language for the EZT-570S. All other language selections provided through internet translation of the English language. CSZ does not guarantee the accuracy or validity of alternative language selections and shall not be liable for any damages or losses, whether direct, indirect, incidental, special, consequential or any other damages for misinterpretation of other languages.

8.5 Special Settings

The “Special Settings” screen is available for special applications when custom settings may be required for certain operating parameters. If available on your system, the “tagnames” for the fields will describe what the setting is for. The value can be changed by touching the field entry window and entering the new setting via the keypad.

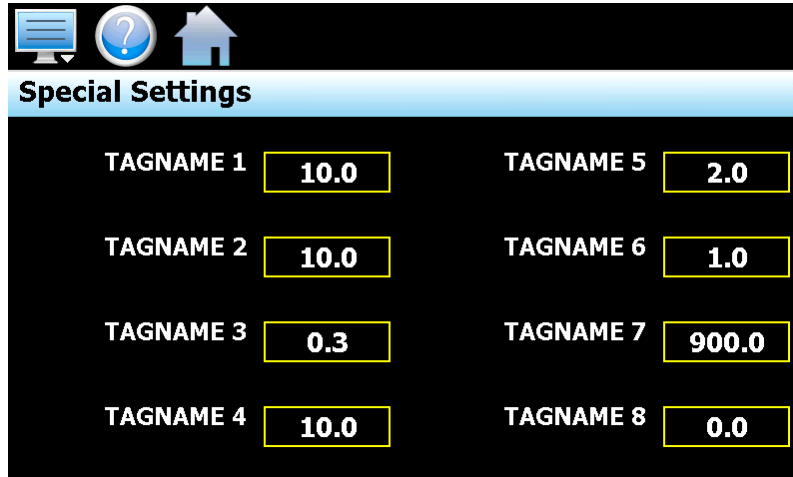

Figure 8-8 Special Settings

! For most systems, these settings will not be available. If the settings are present on your system and you have questions regarding these settings, contact our service department for assistance.

8.6 Hardware

The “Hardware” menu provides access to EZT-570S’s optional analog and digital inputs and outputs. The available selections under this menu are dependent upon the options present on the chamber.

8.6.1 Analog Inputs

The EZT-570S can have up to five analog inputs which are used for remote set point inputs. This menu item will appear if your chamber is equipped with the remote set point option. With this option, electrical connections are provided on the chamber for external connection to each available input.

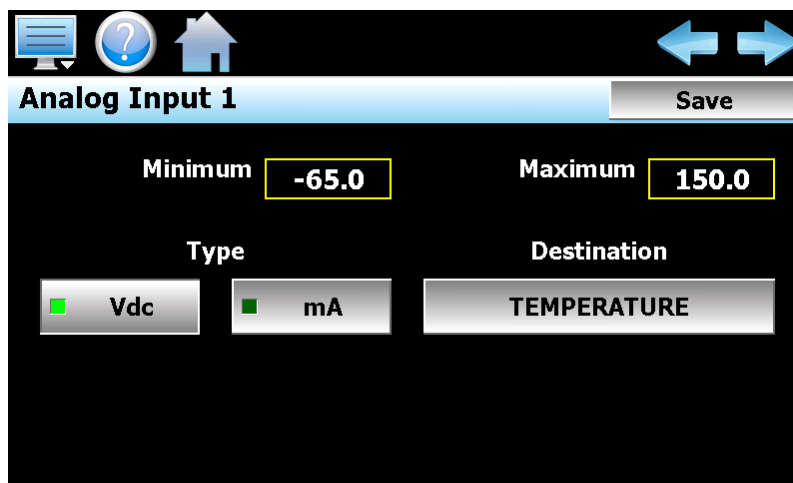

Figure 8-9 Analog Inputs

Use the left or right navigation arrows at the top right of the screen to select the desired analog input to configure an input. To make changes to the analog input's configuration, select the desired input type by pressing the "Vdc" or "mA" button to select either a 0-10V or a 4-20mA input signal. The selections are mutually exclusive, so selecting one input type will deselect the other.

Select the desired loop that the input is to provide the set point for by pressing the destination button. A list will be provided with the available loop selections. Select the desired loop by pressing the on/off button for the loop. The selection is mutually exclusive, so selecting one will turn off the others.

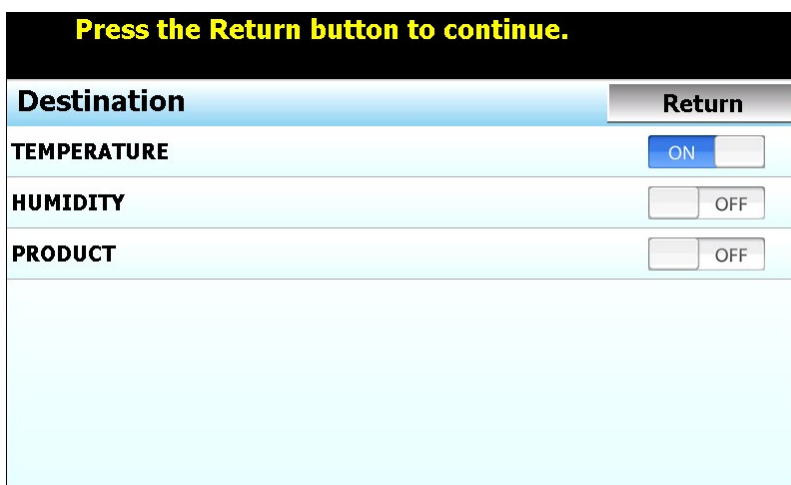

Figure 8-10 Analog Input Loop Select

Once the selection is made, press the "Return" button to go back to the analog input setup screen. Enter the minimum and maximum values for the set point that the input is to provide to the loop and press the "Save" button to save the changes. If you do not press the "Save" button, all changes will be lost if you leave the screen or switch to a different analog input.

! *If you change the analog input type, change from voltage (Vdc) to current (mA) or vice versa, power must be cycled to the EZT-570S controller in order for the input to switch types.*

As the analog input signal is varied, it will provide a linear set point change from the minimum to maximum value over the range of the input. Note that if the minimum or maximum set point generated by the input exceeds the set point limits for the control loop, see Section 5.2, Setpoint Limits, the EZT-570S will limit the set point to the minimum or maximum set point limits value as defined in system setup.

Reversing Set Point Operation

For added flexibility with any type of set point sourcing device, the EZT-570S allows the set point generated by the remote source to be inverted, meaning the minimum input signal, 0V or 4mA, will set the maximum set point while the maximum input signal, 10V or 20mA, sets the minimum set point. This is done by simply reversing the set point entries for the "Minimum" and "Maximum" fields.

For example, an input programmed to generate a set point between -40 and 100 for a 0-10V input signal would be programmed with a "Minimum" of -40 and a "Maximum" of 100. By simply setting the "Minimum" for 100 and the "Maximum" to -40, the set point generated by the 0-10V signal is reversed.

8.6.1.1 Enabling Remote Set Point Inputs

Once an analog input is configured for a particular loop, it must be enabled for use. By default, the EZT-570S uses the set point entered manually from the loop view screen, or from an operating ramp/soak program. The remote set points are enabled through events.

The event allows the user to manually select the use of the remote set point or control its use through an automatic ramp/soak program. Each analog input has its own remote set point event. If the event is on, the set point selected for the input is overwritten and controlled by the input signal. The EZT-570S uses chamber events 11 through 15 for remote set point 1 through remote set point 5.

8.6.1.2 Analog Input Wiring

Locate the analog input connector on your chamber. Figure 8-11 is a representation of the typical analog input connection provided on most chambers; however, as changes and/or improvements are made, your specific connection style may vary. To connect your input signal, first make sure that the input type is set correctly on the EZT-570S as described above.

Next, using a quality, twisted-pair shielded cable, connect your input signal to the correct input number. Make sure to observe proper polarity when connecting your signal leads. Only connect the drain wire of your shielded cable at your signal source, or the chamber, not both. Connecting the shield to ground at both ends of the cable can induce unwanted “noise” into the signal leads.

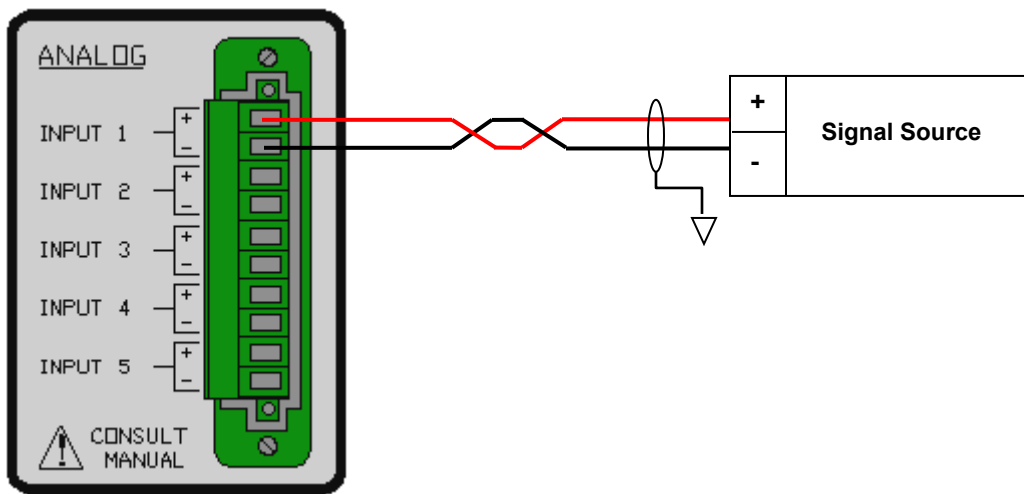

Figure 8-11 Analog Input Wiring

Connect only one signal source to each input. Note that the provided connection may have terminals for all five available inputs; however, your chamber may be equipped with only one based on purchased options. If you are having trouble with getting an input to operate, first make sure that it is available on your chamber.



Exceeding maximum allowed overload ratings can cause permanent damage to the input. Use care when connecting remote signal generators and make sure they cannot overload the EZT-570S's inputs.

Configure the EZT-570S's input for the desired signal level and cycle power prior to connecting the source signal or damage to the input may result.

Input Specifications	Voltage Input	Current Input
Input Range	0-10Vdc	4-20mA
Input Impedance	1M ohm minimum	10 ohms maximum
Maximum Allowed Overload	13Vdc	40mA
Total Error	±1% of full scale	

8.6.2 Analog Outputs

The EZT-570S can have up to four analog outputs which can be used to retransmit set points, process variables or percentages of output from the installed control loops. If your chamber is equipped with optional analog outputs, this menu item will appear in the Hardware menu. With this option, electrical connections are provided on the chamber for external connection to each available output.



Some outputs may be provided for specific control functions depending upon the design of your chamber. Do not alter these output settings unless you are sure that they are used for monitoring purposes only. If you have any questions regarding the use of the output, contact our customer service department for assistance.

The analog outputs can be configured to retransmit signals either in a 0-10V or 4-20mA range. The minimum and maximum values of the output can be set to correspond to a specific value of the retransmitted source. The output will retransmit this source linearly from the minimum to maximum range. To configure an analog output, select “Analog Outputs” from the Hardware menu.

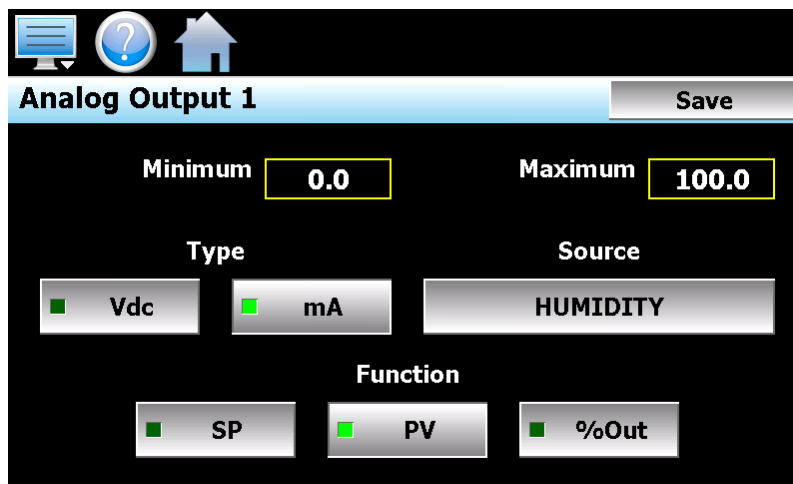

Figure 8-12 Analog Outputs

If more than one analog output is available use the left and right navigation arrows at the top right of the screen to select the desired output. To make changes to the output’s configuration, select the desired output type by pressing the “Vdc” or “mA” button to select either a 0-10V or a 4-20mA output signal. The selections are mutually exclusive, so selecting one input type will deselect the other.

Select the desired loop that the output is to use for the source value by pressing the “Source” button. A list will be provided with the available loop selections. Select the desired loop by pressing the on/off button for the loop. The selection is mutually exclusive, so selecting one will turn off the others. Once the selection is made, press the “Return” button to go back to the analog output setup screen.

Press the function button for the desired loop value that the output is to retransmit. The selections are the loop set point (SP), loop process value (PV) or the loop percentage of output (%Out). The selections are mutually exclusive, so selecting one will deselect the others. Enter the “Minimum” and “Maximum” range of the source value that the analog output is to retransmit and press the “Save” button once all entries have been completed. If you do not press the “Save” button, all changes will be lost if you leave the screen or select a different analog output.



If you change the analog output type, change from voltage to current or vice versa, power must be cycled to the EZT-570S controller in order for the output to switch types.

Reversing Output Operation

For compatibility with external monitoring and control devices, the EZT-570S allows the output signal generated by the input/loop source selection to be inverted, meaning the minimum output signal, 0V or 4mA, will be transmitted when the selected loop source is at its maximum value, and the maximum output signal, 10V or 20mA, will be transmitted when the selected loop source is at its minimum value. This is done by simply reversing the output entries for the “Minimum” and “Maximum” fields.

For example, an application requires a 0-10V output signal from the temperature loop for a cooling output of 0 -100%. On the EZT-570S, 0-100% cooling is represented as a value of 0 to -100%, while heating is 0-100%. In order to transmit the cooling output, set the “Minimum” to 0 and the “Maximum” to -100. The output will then produce a signal from 0 volts at an output of 0% (output minimum) to a signal of 10V at an output of -100% (output maximum).

8.6.2.1 Analog Output Wiring

Locate the analog output connector on your chamber. Figure 8-13 is a representation of the typical analog output connection provided on most chambers; however, as changes and/or improvements are made, your specific connection style may vary. To connect the output signal, first make sure that the output type is set correctly on the EZT-570S as described above.

It is recommended that a quality, twisted-pair shielded cable, is used to connect the output signal to your device. Make sure to observe proper polarity when connecting the signal leads. Only connect the drain wire of the shielded cable at your device, or the chamber, not both. Connecting the shield to ground at both ends of the cable can induce unwanted “noise” into the signal leads.

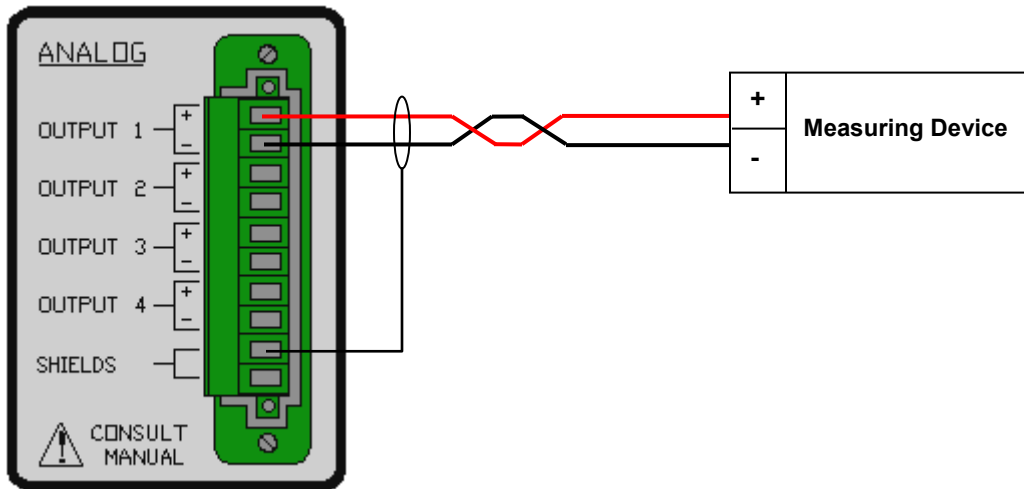

Figure 8-13 Analog Output Wiring

If you connect more than one device to each output make sure that you do not exceed the output capabilities of the EZT-570S. Note that the provided connection may have terminals for all four available outputs; however, your chamber may be equipped with only one based on purchased options. If you are having trouble with getting an output to operate, first make sure that it is available on your chamber.



Exceeding the recommended load impedance for the output will cause signal degradation and may damage the output. Use care when connecting remote devices and make sure they stay within output capability. Configure the EZT-570S’s output for the desired signal level and cycle power prior to connecting the load device.

Output Specifications	Voltage Output	Current Output
Output Range	0-10Vdc	4-20mA
Load Impedance	2K ohm minimum	300 ohms maximum
Applicable Load	resistive	
Total Error	±1% of full scale	

8.6.3 Digital Inputs

The EZT-570S digital input option provides eight digital inputs which can be used to start and stop an automatic ramp/soak program, hold a program or control optional event outputs. If your chamber is equipped with the digital input option, this menu item will appear in the Hardware menu. With this option, electrical connections are provided on the chamber for external connection to each input.

The digital inputs can be configured to work on either a low to high transition or a high to low transition. Upon seeing the selected transition, the input will perform the action selected from the input function list. To configure a digital input, select “Digital Inputs” from the Hardware menu.

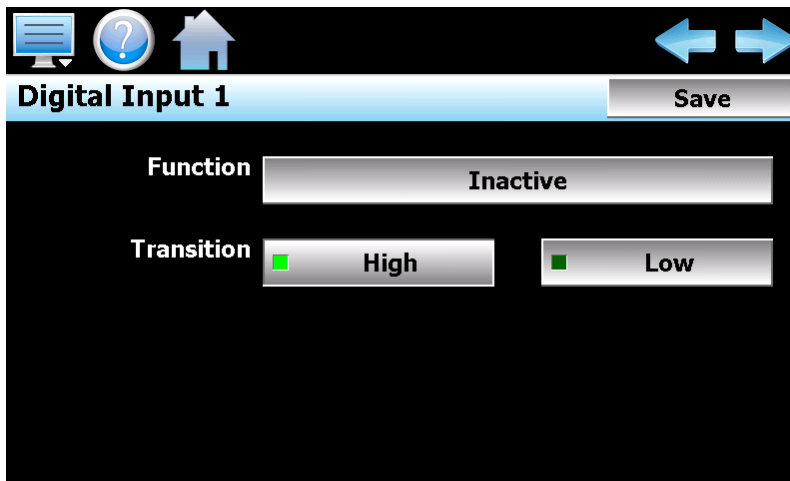

Figure 8-14 Digital Inputs

The left and right navigation buttons at the upper right of the screen allow the user to scroll through each available input. To make changes to the input’s configuration, select the desired transition mode and function for the input. Once all selections have been made, press the ‘Save’ button to save the changes. If you do not press the ‘Save’ button, all changes will be lost if you leave the screen or navigate to another digital input.

! *More than one digital input can be configured for the same function. If more than one is set for the same function, make sure that they do not interfere with each other or the selected function they are to perform may not operate correctly.*

The **Transition** select buttons set the input state that makes the input perform the required function.

High: This setting sets the input up to perform the desired function when the input goes from an off state to an on state. This requires the application of 24Vdc power to the input.

Low: This setting sets the input up to perform the desired function when the input goes from an on state to an off state. That requires the removal of 24Vdc power from the input.

The digital input **Function** defines what event is to happen when the input meets the transition state.

The input Function list is shown when the function selection button is pressed. The input functions selections are mutually exclusive, i.e., only one can be on at a time. An input can be disabled by selecting "Inactive" from the function list. Once the desired selection has been made, press the 'Return' Button to return to the Digital Input screen.

Press the Return button to continue.	
Function	Return
Inactive	<input checked="" type="checkbox"/> ON <input type="checkbox"/> OFF
Run Program	<input type="checkbox"/> ON <input checked="" type="checkbox"/> OFF
Hold Program	<input type="checkbox"/> ON <input checked="" type="checkbox"/> OFF
Continue Program	<input type="checkbox"/> ON <input checked="" type="checkbox"/> OFF
End Program	<input type="checkbox"/> ON <input checked="" type="checkbox"/> OFF
Wait Input	<input type="checkbox"/> ON <input checked="" type="checkbox"/> OFF
Previous Step	<input type="checkbox"/> ON <input checked="" type="checkbox"/> OFF

Figure 8-15 Digital Input Functions

Run Program: When selected, the input will start the currently loaded program at step one. If a program is currently running, no action will occur. This is a 'single-shot' activation in which the input must make the required transition state in order to activate the function.

 *If a program is currently operating but it is in hold, the input will put the program into the run state.*

Hold Program: When selected, the input will put a running program into the hold state. If a program is not currently running, no action will occur. This is a 'single-shot' activation in which the input must make the required transition state in order to activate the function.

Continue Program: When selected, the input will put a program that is in hold, into the run state. If a program is not active or the program is not currently in hold, no action will occur. This is a 'single-shot' activation in which the input must make the required transition state in order to activate the function.

End Program: When selected, the input will turn the program off. This will also turn off all system events. If a program is not running, no action will occur and event status will not be affected. This is a 'single-shot' activation in which the input must make the required transition state in order to activate the function.

Wait Input: When selected, the input acts as a trigger input for a ramp/soak program wait for digital function. The input can then be selected in the program to pause the current step until the input changes state according to the transition mode selection. See *Section 4.1.5, Using Wait For.*



The program must be in the “wait” state prior to the input making the desired transition. If the input makes the transition prior to the program entering the wait for input state, the program will not continue.

Previous Step: When selected, the input will advance the ramp/soak program to the next step. The program must first be placed in hold prior to the input turning on in order for the step change to take place.

Next Step: When selected, the input will advance the ramp/soak program to the previous step. The program must first be placed in hold prior to the input turning on in order for the step change to take place.

*** Chamber Outputs Off:** When selected, the input will cause all chamber control outputs to turn off. The outputs will stay off as long as the input is on. When the input turns off, all outputs will return to normal operation.

*** All Outputs Off:** When selected, the input will cause all chamber control and event outputs to turn off. This includes all optional digital outputs configured as customer events. The outputs will stay off as long as the input is on. When the input turns off, all outputs will return to normal operation.

*** Event Outputs Off:** When selected, the input will cause all optional digital outputs configured as customer events to turn off. The outputs will stay off as long as the input is on. When the input turns off, all event outputs will return to normal operation.

*** Event Output Control:** When selected, the input becomes a “switch” which can be used to control optional digital outputs. When a digital output is configured to be controlled by the digital input, it will turn on when the input is on and off when the input is off.



** For the output control modes, the “on” state for the input is defined by the transition mode. If “High” is selected, the input is on when voltage is applied to the input. If “Low” is selected, the input is on when voltage is removed from the input.*

8.6.3.1 Digital Input Wiring

Locate the digital input connector on your chamber. Figure 8-16 is a representation of the typical digital input connection provided on most chambers; however, as changes and/or improvements are made, your specific connection style may vary.

It is recommended that all wiring be of the shielded type. Only connect the drain wire of the shielded wiring at your device, or the chamber, not both. Connecting the shield to ground at both ends of the cable can induce unwanted “noise” into the input wiring. Improper and/or poor wiring practices can cause interference on the digital inputs which may cause erratic or uncontrolled operation.

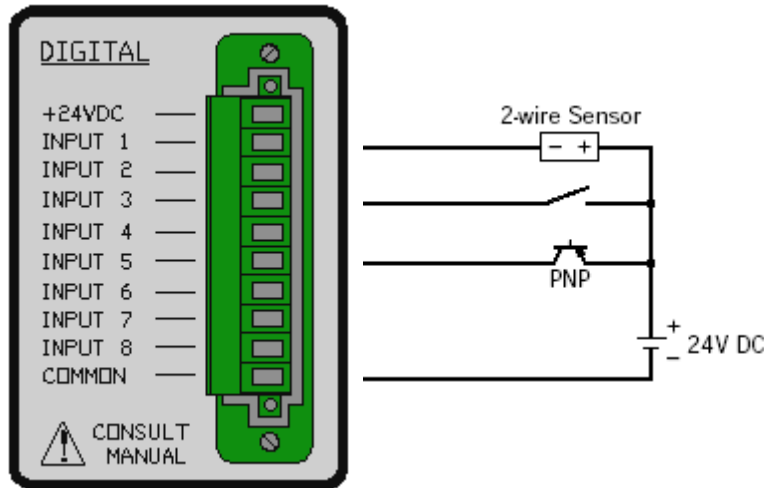

Figure 8-16 Digital Input Wiring

The digital inputs will work with either transistor or potential free (relay) contacts. The input connection provides both 24Vdc power and common terminals for use with the digital inputs. Power can also be provided by a separate source. In order for a separate source to work properly, the common terminal of the external power supply must be connected to the common terminal on the input connector.



Do not connect the +24Vdc terminal on the chamber to the output of another power source or in series with an external source. Doing so can cause irreparable damage to the EZT-570S and may result in a hazardous shock or fire.

Do not exceed the digital input voltage range or damage to the input may occur. The +24Vdc supply is of limited power and for sourcing the inputs only. Do not use this to power other devices or short the +24Vdc and common terminals together. Damage to the power supply may occur.

Digital Input Specifications	Voltage Input
Input Range	20.4 to 28.8Vdc
Input Impedance	3.4K ohm
Rated Input Current	7mA/point
Response Time	1 second maximum

8.6.4 Digital Outputs

The EZT-570S digital output option provides 15 digital outputs which can be used as event outputs, alarm outputs or for other signaling needs. This is a common menu item and will be present even if your chamber is not equipped with the optional digital outputs. If your chamber is equipped with the optional digital outputs, electrical connections will be provided on the chamber for external connection to each of the outputs.

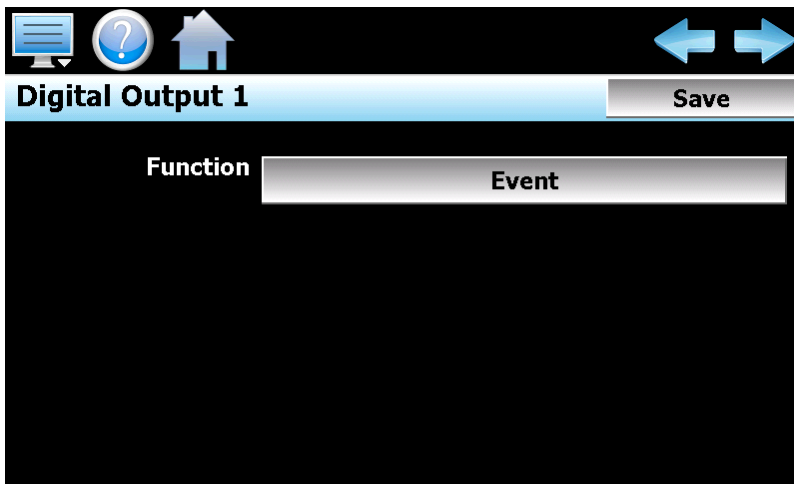

Figure 8-17 Digital Outputs

The left and right navigation buttons at the upper right of the screen allow the user to scroll through each available output. To alter the function of the output, press the function button. A list will be provided with the available selections. Select the desired function by pressing the on/off button for the function. The selection is mutually exclusive, so selecting one will turn off the others.

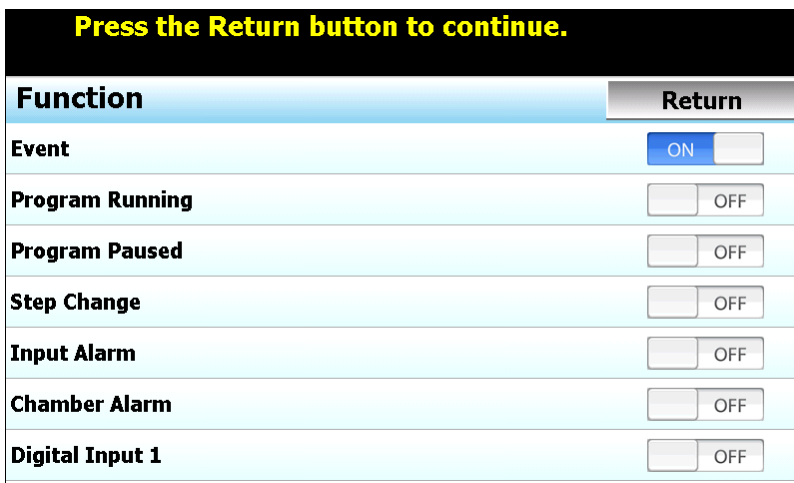

Figure 8-18 Digital Output Functions

Once the selection is made, press the “Return” button to go back to the digital output setup screen. Press the “Save” button to save the change. If you do not press the “Save” button, the change will be lost if you leave the screen or switch to a different digital output.

The output function defines what condition causes the output to turn on and off. All digital outputs are configured as event outputs by default. More than one output can be set for the same function.

Event: When selected, the output is controlled directly from the corresponding event on the Overview screen and Program Entry screen. When the event is selected, the output turns on. When the event is not selected, the output turns off.

Program Running: When selected, the output will turn on when a ramp/soak program is active. The operating condition is defined as a ramp, soak, guaranteed soak or wait for condition. The output will not be on if the program is in AutoStart, since it has not yet started, or when it is placed in hold by an operator.

Program Paused: When selected, the output will turn on when the program is in hold. When the program is in any other condition, the output will be off.

Step Change: When selected, the output will provide a one-shot pulse each time the program changes steps. This also includes an output pulse each time the program is manually advanced to the previous or next step while in hold.



When a program is started, the output will pulse when the first step of the program is started.

Input Alarm: When selected, the output can be controlled by a loop/monitor input alarm. The alarm must be configured to control the output. See Section 5.4, Alarms for information on assigning the alarm to the event output. This output mode provides a way of controlling devices at specific temperature or humidity levels for example.



If more than one alarm is assigned to the output, the output will not operate correctly and may cycle on and off uncontrollably. Do not assign more than one alarm to an output.

Chamber Alarm: When selected, the output will turn on when a critical alarm occurs. The output will stay on until the alarm is reset. This output mode provides a remote alarm notification that operates in conjunction with the chamber's audible alarm. Note that the alarm condition may still exist with the output turned off.

Digital Input 1-8 These mode selections are used to assign the output to one of the digital inputs. It allows a digital input to turn the output on and off directly. Any of the eight available inputs can be selected for control of the output.



The digital input must be configured for event output control for the output to be controlled by the assigned digital input. If the input is not configured for event output control, the output will remain off.

8.6.4.1 DUT Safety Relay Output Wiring

The DUT safety relay connection is provided as standard on most chambers. To connect to this relay, locate the digital output connector on your chamber. The DUT connection is located on the digital output connector panel (see Figure 8-19).

The DUT safety relay is an isolated dry contact rated for up to 2A of current (resistive) at 24V AC/DC. It provides an effective and safe method of removing power from test items within the chamber any time the chamber is not running. Leaving devices powered within a chamber that is not operating can cause catastrophic damage to the test item and/or chamber in very short periods of time depending upon the heat output of the device.

8.6.4.2 Digital Output Wiring

Locate the digital output connector on your chamber. Figure 8-19 is a representation of the typical digital output connection provided on most chambers; however, as changes and/or improvements are made, your specific connection style may vary.

If using the digital outputs for low level signals to solid state circuitry, it is recommended that all wiring be of the shielded type. Only connect the drain wire of the shielded wiring at your device, or the chamber, not both. Connecting the shield to ground at both ends of the cable can induce unwanted “noise” into the wiring and subsequently, your device.

If using the digital inputs for controlling other relays coils or powering small devices, the wiring method is at the operator’s discretion, but a minimum of #24AWG wire is recommended. Low voltage signals can become quickly degraded when using smaller gauge wire due to the resistance of the wire over long distances.

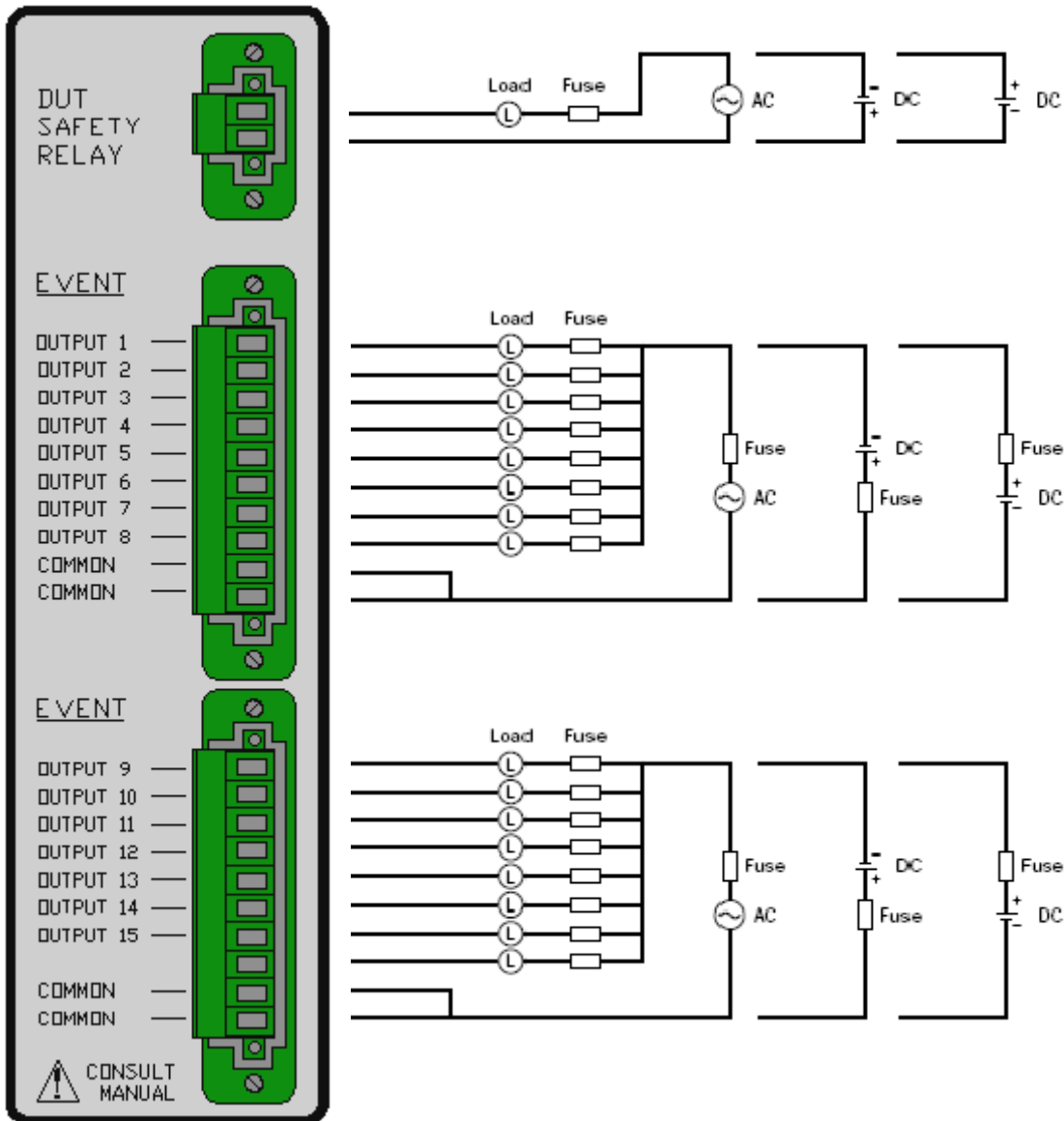

Figure 8-19 Digital Output Wiring



The digital outputs are potential free dry contacts divided between two common headers. Each output is rated for 2A of current with a maximum of 8A per common line. If all outputs are being used, the sum of the current must not exceed 8A.

Digital Output Specifications	Voltage Input
Maximum Load Current	2A/point 8A per common line
Minimum Switching Load	0.1mA/0.1Vdc (reference value)
Response Time	1.7 seconds maximum

8.7 Monitor Offset Calibration

The analog inputs associated with the control loops, i.e., temperature, humidity, product, etc., are not accessible through this menu item. They must be accessed directly from the PID loop controllers. See Chapter 4, “Calibration”, of the Future Design Controls, FDC-9300 Self-Tune Fuzzy / PID Process / Temperature Controller User’s Manual or Chapter 5 “Calibration”, of the FDC C21/C91 Auto-Tune Fuzzy / PID Process / Temperature Controller User’s Manual provided with your chamber for procedures and instructions on calibrating the control inputs.



Do not alter any other parameters or settings within the 9300 or C21 controllers. Any changes made to CSZ factory settings may cause unpredictable operation of the chamber which can result in damage to equipment and will void the chamber warranty.

The Calibrate/Offset menu will appear if your chamber is equipped with the optional monitor inputs package. The monitor option provides up to eight thermocouple inputs for monitoring temperatures throughout the chamber. The calibration range is fixed within the EZT-570S hardware; however, the user can input an offset in order to adjust for sensor tolerances and lead affects.

Through the use of a simple ice bath, all sensors can be corrected within a matter of minutes without having to disconnect leads or have expensive calibration equipment. With the chamber at ambient temperature, place a bucket of ice filled with water in the chamber. Place all monitor input thermocouples into the ice bath. Allow the probes to soak for a minimum of 30 minutes BEFORE entering an offset.

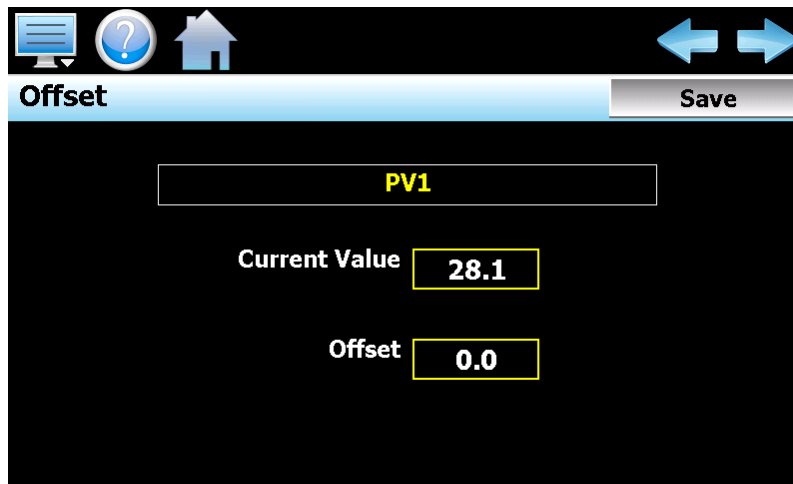

Figure 8-20 Monitor Offset calibration

Select the desired input by using the navigation arrows at the top right of the screen to enter an offset for a monitor input. The current value of the input and applied offset will be shown. The reading should be 0°C (32°F), i.e., the ice bath temperature. To “zero” the input, enter the offset value in the “Offset” field and verify the reading. Be sure to press the “Save” button to save the new offset value before proceeding onto other inputs or leaving the screen or the offset value will not be used. The total error for the monitor inputs is +3.5°C (6.3°F).

Changing Monitor Input Names

The name of each monitor point can also be changed by the user to better describe the measurement it is performing. To change the name of a monitor point, touch the name of the monitor point. A keypad will be shown allowing a new name to be entered (up to 17 characters) for the monitor point.

8.7.1 Refrigeration Monitor Option

If the chamber is equipped with the refrigeration monitor option, the monitor inputs will be used to display the suction and discharge temperatures and pressures of the refrigeration system compressors. The pressure sensor inputs are in absolute pressure (PSIA), not gauge pressure (PSIG). In order to display the refrigeration system pressures in gauge pressure, the offsets for the pressure monitor inputs will be set to a default value of 14.7 (standard atmospheric pressure). This converts the absolute pressure readings to gauge pressure.

- ! The EZT-570S uses 9300 controllers to monitor the refrigeration system temperatures and pressures. One 9300 is used for each suction and discharge line. Input 1 of the 9300 is temperature and input 2 is pressure. The monitor input offset can be used to correct for slight errors in readings; however, actual calibration of the inputs must be performed at the 9300.

8.8 Display Settings

The Display screen provides access to the touch screen calibration utility, back light settings and alarm volume.

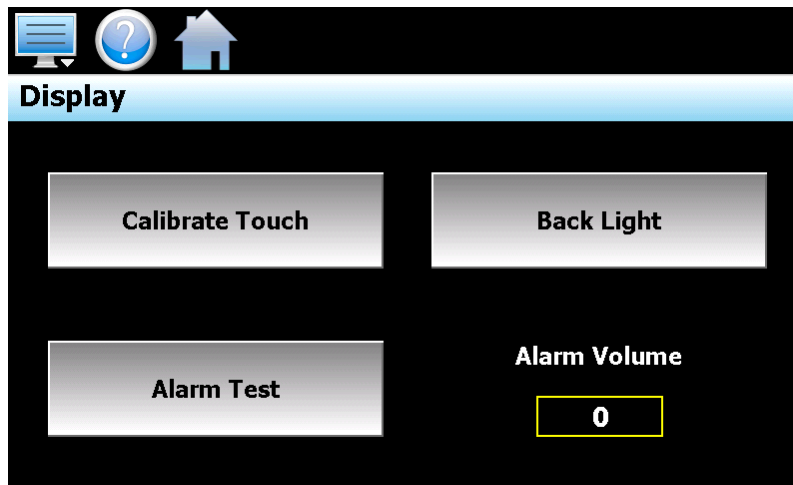

Figure 8-21 Display Settings

The **Alarm Volume** adjusts how loud the internal alarm buzzer of the EZT-570S will be when activated under an alarm condition. It does not affect the external audible alarm on the chamber (if equipped). The volume can be set from 0 (off) to 100. To edit the alarm volume, touch the entry field and enter the desired volume level. To test the buzzer, press the “Alarm Test” button.

8.8.1 Calibrate Touch

After extended use and many hours of operation, it may be necessary to recalibrate the touch screen of the EZT-570S. A typical sign that the screen may be out of adjustment, is inaccurate responses when attempting to press buttons, check boxes or adjust fields on the display. The calibration utility is provided in order to readjust the screen when this happens.

To begin the calibration process, press the “Calibrate Touch” button. An alert message will appear stating that the application will be disabled to perform the calibration procedure. Press “Yes” to continue.

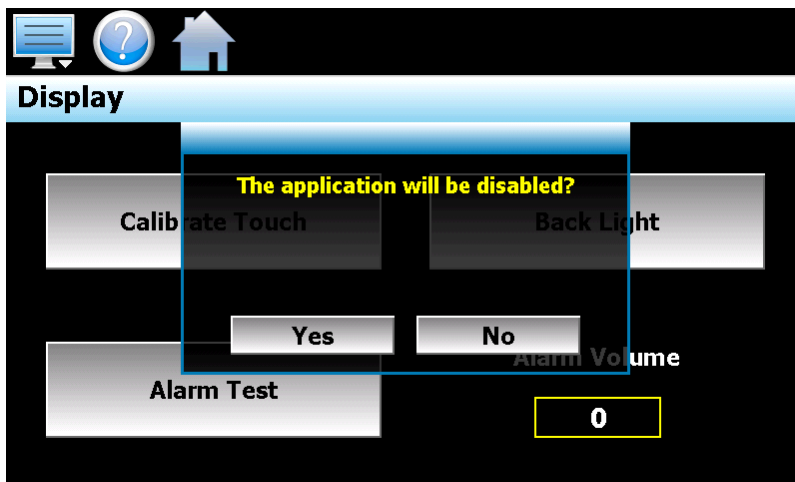

The calibration utility will start and crosshairs will appear on the screen. At each crosshair position, touch the screen at the center of the crosshairs. Repeat this for each position in order to set the calibration. The calibration requires five points, the center and four corners.

- ! *It is recommended that you use your finger rather than a stylus when calibrating the screen. The touch response will be more fluid after calibrating it with your finger.*

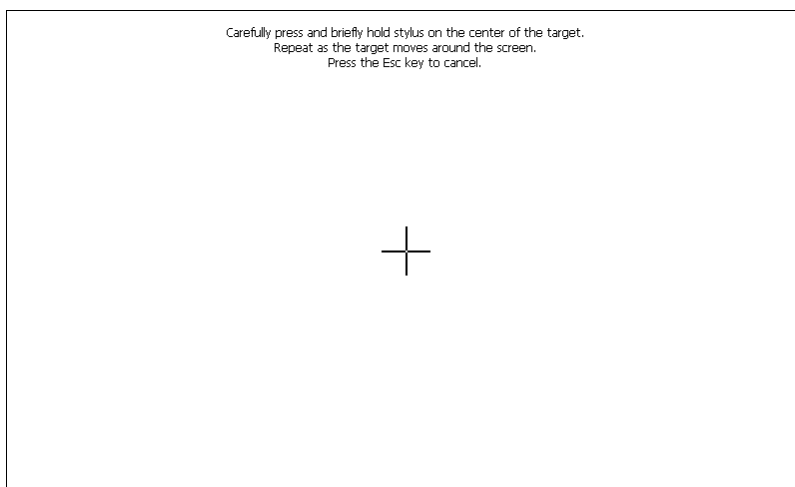
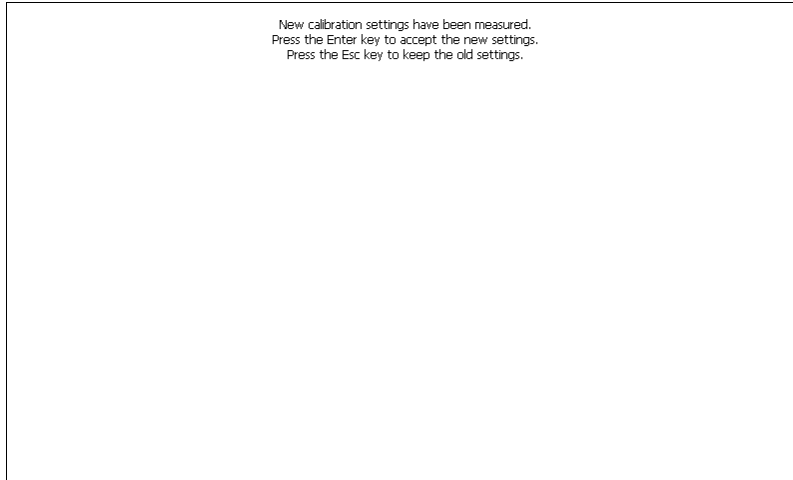

Figure 8-22 Display Calibration

Once complete, the calibration utility will provide a notification message that the new calibration settings have been measured and to touch the screen to register the new calibration data; just touch anywhere on the screen to close the window and return to the EZT-570S application to resume normal operation.



8.8.2 Backlight Settings

The backlight settings allow the user to adjust the screen brightness as well as set a time period for dimming the backlight after a period of inactivity which can extend the life of the display. To adjust the backlight settings, press the “Back Light” button. An alert message will appear stating that the application will be disabled to enter the backlight settings. Press “Yes” to continue.

Select the “Backlight” tab from on the Display Properties window. Press the “Advanced...” button to access the settings for the backlight.

- ❗ *The checkboxes on the Backlight tab for “Automatically turn off backlight while on battery power” and “Automatically turn off backlight while on external power” have no effect on backlight operation and should be left unchecked.*

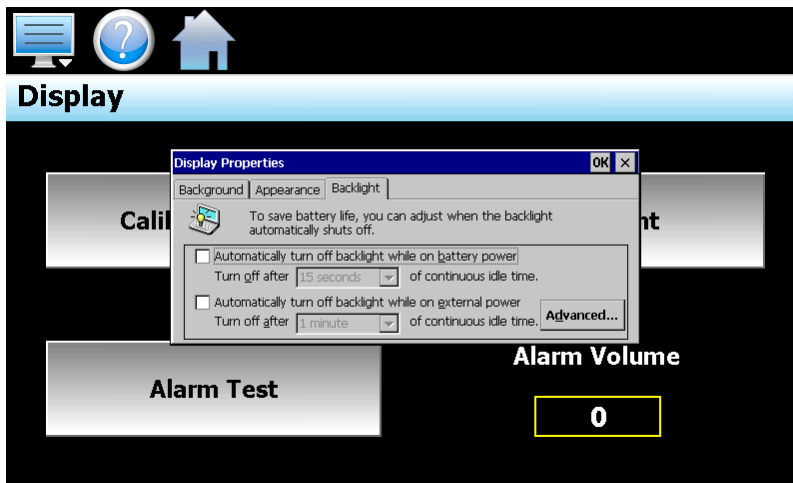

Figure 8-23 Display Properties

The brightness of the display during operation is set by adjusting the “Run” slider. The default setting is 100. The “User Idle” slider is used to adjust the brightness of the display during periods of inactivity. The default setting is 5. Note that as you adjust the slider, the display will temporarily dim to the selected level to indicate how the selected brightness level will appear.

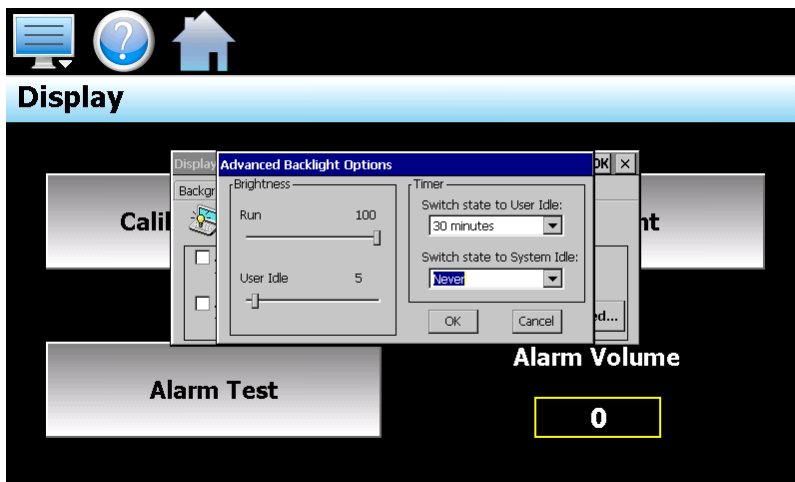

Figure 8-24 Advanced Backlight Options

To enable the backlight dimming function, selected the desired delay time from the “Switch state to User Idle” drop down selection box. The delay time can be set at fixed intervals from as little as 1 minute to as long as 30 minutes.

Once all settings are complete, press the “OK” button and then press the “OK” button at the top right of the “Display Properties” window to return to the EZT-570S application and begin normal operation.

8.9 Configuration

The Configuration utility allows the user to back up the settings of the EZT-570S and save it to a file for “safe keeping” in case of system damage due to a lightning strike, etc. The utility also allows the EZT-570S to be configured with a push of a button by selecting from a list of preconfigured setups that could be created and saved on a USB memory device or remote server for import to a new EZT-570S.

⚠ Do not import configuration files that are not intended for use with the current chamber type and hardware configuration of the EZT-570S. Consult our service department before using the import function. Importing system configurations not intended for use on your model of chamber may damage to system components and will void the chamber warranty.

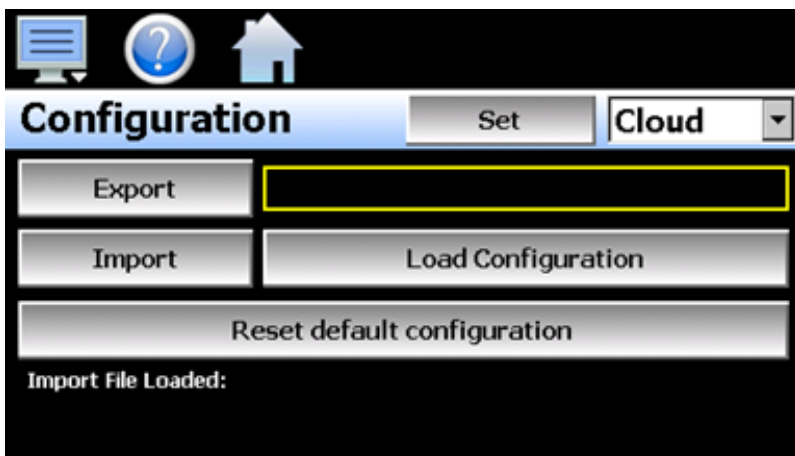

Figure 8-25 Configuration

By default, the import/export procedure is set to operate via USB. To perform import/export operations from a remote server, use the drop-down menu to select “Cloud”. When “Cloud” is selected, a “Set” button will appear to the left of the drop-down menu. Pressing the button will display the Cloud setup screen where the remote server settings can be entered (See section 8.9.1 Cloud Server Settings). The settings only need to be entered once as they can be saved and used for any future import/export operations.

When the **Export** button is pressed, the EZT-570S configuration data will be written to the USB memory device or remote server. The export file function will use the name entered in the text field to the right of the export button and create a directory on the memory stick with that name, to contain the configuration data. The filename can be entered with up to 10 characters which permits multiple configurations to be identified and saved for later retrieval.

The export file will be saved with a name format of “570S_ *filename* _mm-dd-yyyy-hh-mm-ss” to identify the configuration according to the date and time it was created. This prevents multiple configuration files with the same name from overwriting previous files. It also allows the user to identify a backup of the EZT-570S so that it could be reconfigured to a previous date if multiple back-ups are created.

The **Import** button is used to write the configuration data to the EZT-570S from the currently loaded file. To load a configuration file, the USB memory device must first be inserted into the USB port (or the remote server has to be properly configured and the EZT-570S connected to the internet when Cloud is selected). When the **Load Configuration** button is pressed, a list of available configuration files from the memory stick (or remote server) will be shown.

Select the desired file from the list and press “Open” to load the file. Once the file is loaded, the import process can begin. Pressing the “Import” button will begin the process. When the import is complete, you must cycle power to the EZT-570S in order for the new configuration data to be loaded into runtime memory for proper operation.

The **Reset default configuration** button can be used to clear the current EZT-570S configuration and reset the system back to default values. This function clears all user configuration values and returns the system to an “as new” factory state allowing the system to be configured from scratch. This function is provided as a means to start over in the event that the system configuration has been altered to an unknown state and is not operating properly, and a known good configuration is not available to import.



The configuration functions do not affect the VNC server configuration. The enable state, VNC address, device name and password fields must be manually changed as these settings are specific to each device and must be set independently for proper VNC server operation over a network.

The network settings, i.e., DHCP/ Static IP address settings are also not saved to the configuration file. These settings must also be done manually.

The configuration functions do not affect the 9300 or C21 loop controls. The individual PID loop controls must be configured manually through the front panel of the device in order to make changes to the settings for controlled process (temperature, humidity, product, etc.).

8.9.1 Cloud Server Settings

The “Cloud” screen provides settings for the remote configuration FileWeb server. The screen is accessed by pressing the “Set” button on the Configuration screen. Note that the “Set” button is only shown when “Cloud” is selected for the import/export configuration location.

Press the Cancel or Save button to exit screen.

Cloud	Cancel	Save
IP Address	https://fdcutil.com/FDDataService.svc	
Server		
User Name	*****	
Password	*****	

The **IP Address** field is used to enter the IP address of the remote server site that EZT-570S is to interface with.

The **User Name** field allows you to enter a user name for site access. When the EZT-570S connects to the site, the user name will be used to identify the connection. The user name is required for FileWeb access.

The **Password** field is used in conjunction with the user name field and is for entering a password, so the EZT-570S can access the site. A password is required for FileWeb access.

The **Server** field is used to enter additional directory information for the server (if desired) where the files are to be stored during import/export operation. The field can be left blank. By default, the EZT-570S is hard coded to store files on the specified server in the “\configs\user name\” directory. If an entry is made in the Server field, the path would be “\configs\user name\server\”.

EZT-570S Field Setup	FileWeb Server Setup
IP Address = https://cszutil.com/FDDataService.svc	Actual named address of FileWeb server/service.
Server = <i>optional path</i>	<p>The FileWeb server/service must be configured with a root “\configs\” directory in order to use the EZT-570S cloud import/export feature. The EZT-570S is hard coded to transfer configuration files to the “configs” directory in the root of the server. This results in a typical file path of “\configs\userName\”. If the Server field also contains an entry, the resulting path would be “\configs\userName\Server\”.</p> <p>It is recommended that this field be left blank for the majority of users to ensure all configuration files are stored in the base “configs” directory. When loading a configuration for import, only the files in the specified directory will be available for selection. If a configuration file was stored to a location specified by the Server field and the proper entry is not known, the user will be unable to select the proper configuration file for import.</p>
User Name = <i>userName</i>	Actual user name for login at FileWeb server (required).
Password = <i>userPassword</i>	Actual password for login at FileWeb server (required).

- ! *Make sure proper permissions are set at the server for access/creation of directories and read/write access. Also check root directory structure at the server to identify the actual root that was created for the files since there can be additional layers created by the server field and displayed in the path (see Appendix section FTP, FileWeb, DataWeb Requirements/Installation for additional information).*

8.10 About the EZT-570S

The “About” screen provides operating system version numbers for the currently installed firmware and program of both the EZT-570S HMI and control module. This information should be recorded prior to any service request so that proper assistance can be provided for your chamber.

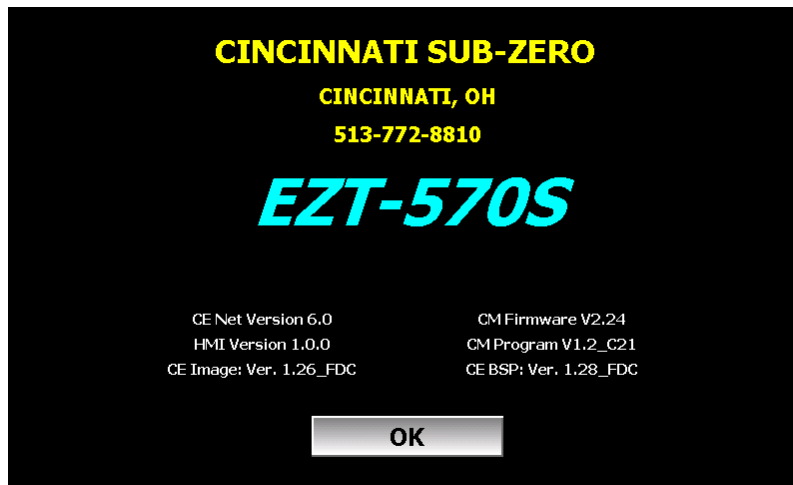

Figure 8-26 About EZT-570S

8.11 Exit Application

The “Exit” Application screen allows the user to quit the EZT-570S runtime software and return to the CE.Net operating system. This operation is NOT recommended with the exception of users who are in charge of system configuration due to the danger of editing or removing files by accident.

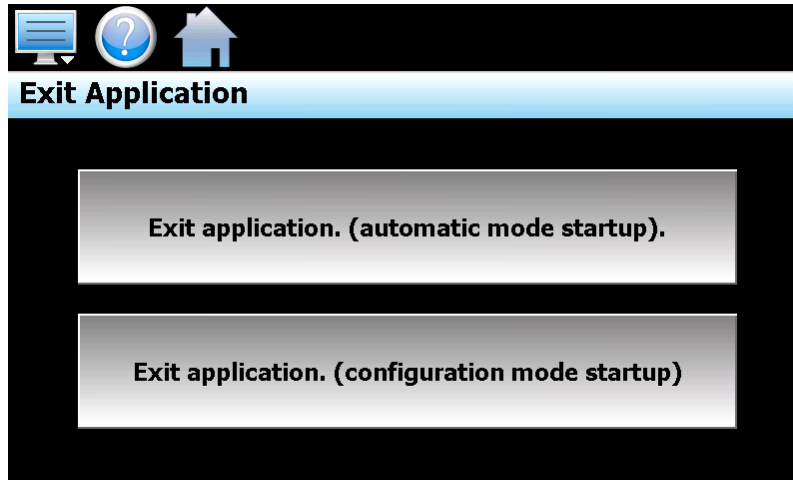

Figure 8-27 Exit Application

The **automatic mode startup** option will return the EZT-570S to normal operation on the next power up.

The **configuration mode startup** option will start the EZT-570S chamber configurator program on the next power up so that the user can access chamber configuration settings.



The exit configuration mode startup option is for CSZ Products factory authorized service personnel only. Do not alter any chamber configuration settings without the expressed permission of our service department. Altering chamber configuration settings can cause chamber malfunction and may damage system components. Unauthorized changes will void the chamber warranty.

9. Communications

This section covers the connection to, and basic use of the EZT-570S communication interfaces. As a standard, the EZT-570S is equipped with both EIA-232 and EIA-485 serial interfaces as well as the standard network communications port. The EZT-570S can also provide an IEEE-488 (GPIB) communication port through the use of an optional interface converter.

To connect to the available communication ports, locate the communications connector panel on the chamber.

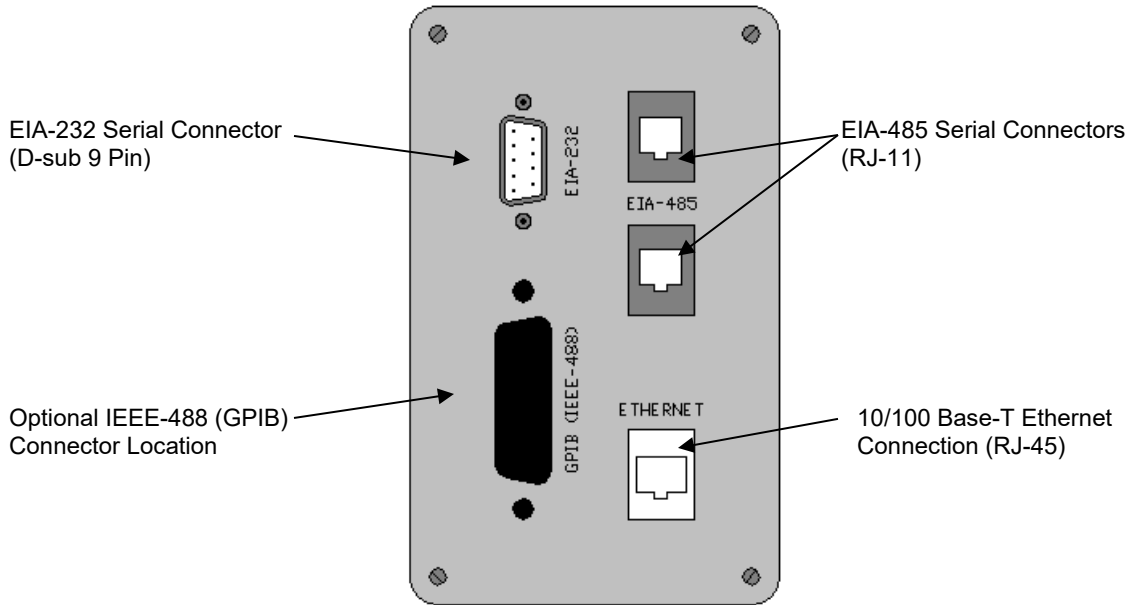

Figure 9-1 Communications Connector

9.1 Serial Communications

The EZT-570S uses Modbus RTU protocol for serial communications. The EZT-570S communication address and parity can be changed on the User communications screen located under the system settings menu.

The screenshot shows a configuration screen with a black background and white text. At the top right, the date and time are 4/1/2019 5:35 AM. Below this are several icons: a list, a question mark, a house, and a lightbulb. The main area contains the following settings:

- Modbus Address: 1
- Parity: Even
- VNC Address: 0
- Pswrd: None
- VNC Device Name: EZT570Sv
- VNC Password: *****
- IP Address: 192.168.0.30

At the bottom, there are four buttons: Wwww. (with a green square), VNC (with a green square), Ethernet, and Save.

Figure 9-2 Modbus Settings

- ! The EZT-570S is set by default for an address of 1 and even parity for use with CSZ's EZ-View software package. If another software package is being used, or you are writing your own custom application, see the EZT-570S User Communications Reference Manual for instructions and information on command structure and protocol usage.

9.1.1 Adjusting Modbus Serial Communication Settings

The Modbus serial communication settings allow the EZT-570S to be used on a single (RS232) or multi-drop (RS485) serial link. The settings must be set to match that of the host computer and vice versa. The serial port settings of the EZT-570S are fixed other than the controller address and parity. The host computer's serial port must be set to match the fixed EZT-570S port settings:

Address: 1-247 (user selectable)
 Baud Rate: 9600
 Data Bits: 8
 Stop Bits: 1
 Parity: none, odd, even (user selectable)

The **Modbus Address** is used to identify the EZT-570S on the serial link. When a multi-drop connection is used, each controller on the link must have a different address so that each one can be identified separately. If two or more devices have duplicate addresses, communications with those devices will fail because they will all try to respond to the same message. For single controller connections, the address only needs to match that of the commands being sent from the host computer.

The **Parity** setting is an extra level of error checking that the serial ports of devices can use to verify that the data received is what was sent. All devices on the serial link must be set to the same parity setting or they will not transmit and receive data the same way. Thus, communications will fail between devices that do not have the same settings.

9.1.2 EIA-232 Connections

To connect the EZT-570S to a PC's serial port, a null-modem cable is required. This type of cable is designed to allow two devices to communicate with each other via their serial ports. This cable differs from that of a standard cable because the transmit and receive wires are reversed. If one is not available, a cable can be fashioned rather easily. Use a high-quality shielded cable and connect the leads as shown below:

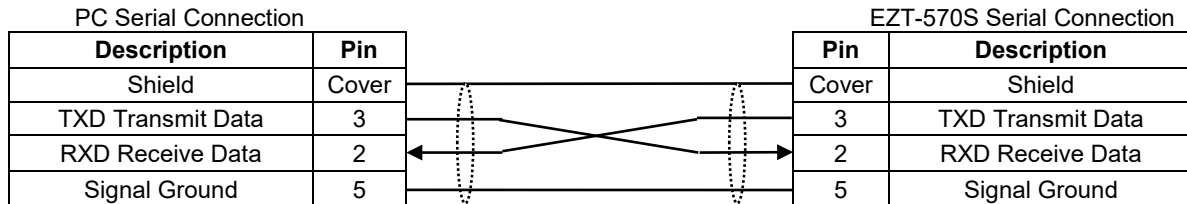

Connect the cable between the chamber's serial port and the desired serial port on the PC. Make sure that the serial port settings of the EZT-570S and the host computer match, and be sure to save any changes to the EZT-570S communication settings. Cycle power to the EZT-570S if any serial communication settings have been changed and the serial connection is ready for operation.

9.1.3 EIA-485 Connections

The EZT-570S communication interface supplies two RJ-11 connectors for convenient daisy-chaining of multiple chambers to a single PC's serial port. The connection requires only two wires, pins 3 and 4 of the RJ11 connector. The PC's serial port must be capable of RS-485 half duplex communication or an interface converter must be used. CSZ has tested the following converters for compatibility with the EZT-570S.

B&B Electronics
707 Dayton Road
PO Box 1040
Ottawa, IL 61350
Phone 815-433-5100
<http://www.bb-elec.com>

RESmith
4311 Smith Drive
Hamilton, OH 45011
Phone 513-874-4796
<http://www.RS485.com>

Part # **485OI9TB** for EIA-232 to EIA-85
Part # **485PS2** (external power supply)

Part # **ASC24T-B9FPS**
(provided with all cables and power supply)

When connecting multiple chambers together, do not run separate cables from the PC to each chamber. Follow the diagram below for proper connections. Running multiple connections from the host PC will degrade the signal and could prevent communications from operating correctly.

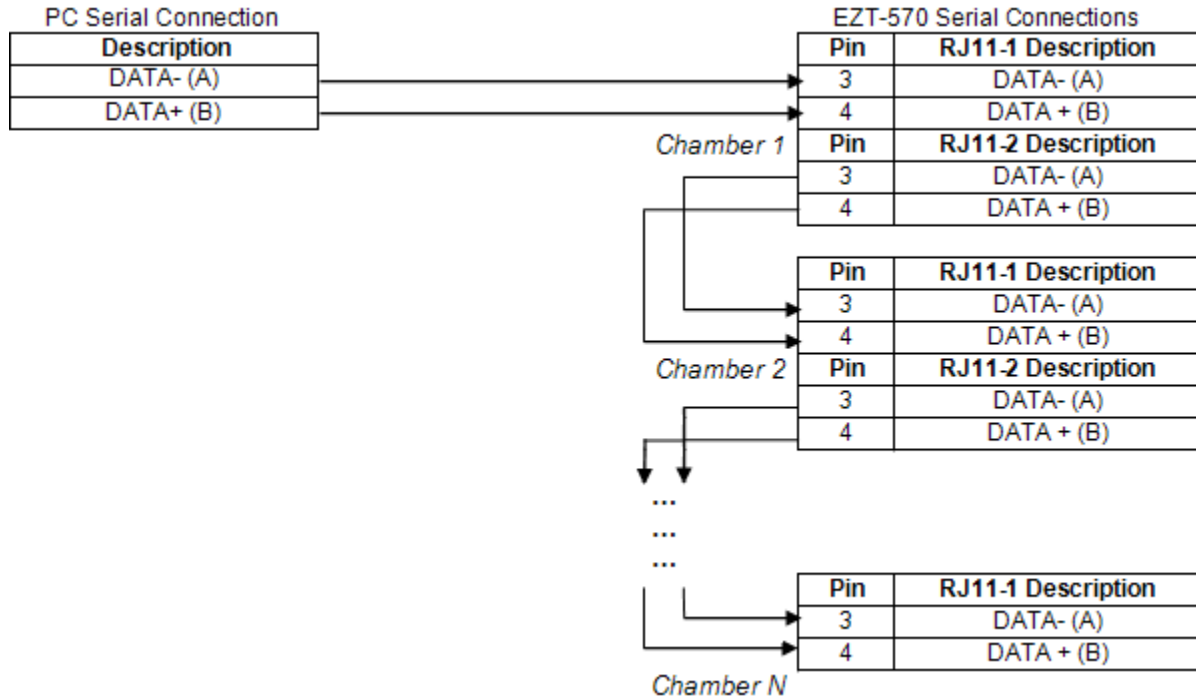

Hold the RJ11 connector in your hand, tab side down, with the cable opening towards you. The pins are numbered 1-6, from right to left:

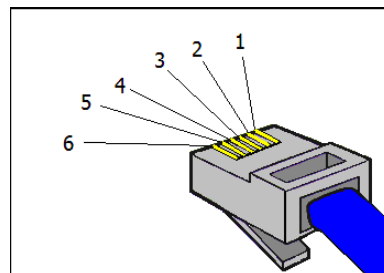

- ! Either RJ-11 connector on the chamber can be used for the connection from or to another chamber. There is not a designated "in" and "out" connection. Keep the communication wires as short as possible between chambers. The total length adds up quickly, and longer runs will degrade performance. Maximum recommended total length is 350 feet, but is by no means guaranteed. The total length depends on many factors including the quality of wire used, the number of chambers on the link and the presence of electrical equipment in the area that may generate electrical interference.

For longer runs and when multiple chambers are used on the same link, a line terminator may be required at the end of the cable run. This is typically a 220-ohm resistor connected across the A and B terminals of the last chamber on the link. See the manufacturer's instructions for your specific EIA-485 communications interface used with your PC for any requirements that they may have to be followed.

9.2 GPIB (IEEE-488) Communications

The GPIB communication option is provided through the use of ICS Electronics Model 4899 GPIB-to-Modbus Controller. The 4899 is an IEEE 488.2 compatible GPIB device that can control single or multiple Modbus slave devices. It accepts simple GPIB bus commands that are used to create Modbus RTU packets which are then transmitted serially to the Modbus slave device(s). The data transmission can be to a single Modbus device over an EIA-232 link or to multiple Modbus devices over an EIA-485 network.

The controller's SCPI parser accepts IEEE-488.2 common commands, SCPI commands and Modbus commands. The IEEE-488.2 and SCPI commands are used to setup the controller's status reporting structure or to configure its GPIB and serial interfaces. Any commands that end in a '?' are a query and the controller responds by outputting the requested data on the GPIB bus the next time it is addressed as a talker.

The 4899 includes a list of commands for controlling Modbus devices. These commands specify the Modbus slave device address, a read or write operation, a register number and data or the number of registers to be read. When the Controller receives a read (R) or write (W) command, it converts the GPIB characters into HEX bytes, assembles the packet, and transmits it to the Modbus device. This simplifies communications with the EZT-570S by automatically handling the Modbus protocol.

If your chamber is equipped with the optional GPIB communications port, connect the chamber to your PC's GPIB port using the appropriate style cable. Up to 15 devices can be connected on a single GPIB bus.



The 4899 converter interface is configured with a default address of 4 on the GPIB bus. The address can be changed by using the proper command string.

The EZT-570S's serial communications address should be set to 1. This is the default address that the 4899 converter will use when communicating over its serial interface to the EZT-570S.

See the EZT-570S User Communications Reference Manual for the list of data registers and their settings for controlling the EZT-570S over the GPIB interface.

9.2.1 GPIB Command Structure

There are six basic commands that are required to configure and operate the GPIB controller in order to communicate with the EZT-570S controller. These commands are listed in the table below. All commands are generated using standard ASCII text characters.

Command	Use
SYST:COMM:GPIB:ADDR <i>addr</i>	<p>GPIB Address Command</p> <p>Sets the GPIB controller's device address for subsequent commands. Value for <i>addr</i> is 1 to 31. This is the address you will use to communicate with the EZT-570S over the GPIB bus.</p>
*SAV 0	<p>Save Configuration Command</p> <p>Saves current 4899 configuration in nonvolatile memory so that on next power-up, settings such as the GPIB address will remain intact.</p>
R[?] <i>reg, num</i>	<p>Read Register Command (reads EZT-570S data values)</p> <p>Reads one or multiple EZT-570S registers. User specifies starting register <i>reg</i> and number of registers to be read <i>num</i>. The [?] is an optional symbol so programs like ICS's GPIBKybd program can recognize the command as a query and automatically read the response. Responses are returned as 16-bit decimal values separated by commas.</p> <p>R? 61,1 reads EZT-570S loop 1 process value. Example response is 527 for 52.7 degrees.</p> <p>R? 60,3 reads three successive registers for loop 1 SP, PV and %Out. Example response is 550,527,10000 for SP of 55.0, PV of 52.7 and %Out of 100.00.</p>
W[?] <i>reg, w</i>	<p>Write Register Command (writes EZT-570S data values)</p> <p>Writes one 16-bit word, <i>w</i> to one EZT-570S register, <i>reg</i>.</p> <p>W 60, 550 writes a set point of 55.0 to loop 1.</p>
WB <i>reg, num, w(0).w(n)</i>	<p>Write Block Command (writes EZT-570S program steps)</p> <p>Writes multiple 16-bit words, <i>w(i)</i> to multiple registers. Starting register, <i>reg</i>. Number, <i>num</i> specifies how many words are to be written.</p>
E?	<p>Read Error Command.</p> <p>Reads and clears the Modbus Error Register and bit 6 in the Event Status Register. Returns an error code whose value is 0 to 255.</p> <p>0 No errors present 1 Exception Code 1 2 Exception Code 2 3 Exception Code 3 100 CRC Error 101 Timeout Error indicates no characters received 2nn Partial or corrupted message, nn is number of received bytes.</p>

9.3 10/100 Base-T Ethernet Communications

The EZT-570S provides several options for remote control and monitoring over the Ethernet communications interface. The web server interface provides a monitor only connection, while the VNC server and Modbus TCP interfaces allow a user to manipulate and control the chamber remotely. The VNC interface allows the user to view and observe operation of the EZT-570S display directly on their PC screen while the Modbus TCP interface allows the user to manipulate chamber operation via other devices and/or software capable of Modbus TCP communications.

 *In order to use Ethernet communications, the EZT-570S must be properly connected to a network. To connect the EZT-570S to a network, connect the chamber's Ethernet port to your network using a standard CAT5 cable connection. After connecting the network cable, it may be necessary to cycle power to the EZT-570S in order for it to obtain a valid IP address from your network.*

9.3.1 Guidelines of Smart Networking Practice

The expansion of Ethernet onto the industrial floor has brought forth a new realm of possibilities from the gathering of information to the inherent control of equipment from anywhere around the world. The flexibility and convenience that this provides makes it a very desirable feature for new equipment. The EZT-570S provides this ability, but there are considerations that must be taken by the end user to protect their equipment and investment.

Just like placing a personal computer on the internet opens it up to outside attack, placing your chamber on a network poses the same risk. The first thing to remember is this: The most likely cause of problems is not a hacker trying to sabotage your equipment, but more often to be related to the ubiquity of PCs with Ethernet cards, the ease with which your own co-workers can 'hang stuff on the network,' and careless or nonexistent internal security measures. Accidental problems are more common than deliberate ones.

Allowing anyone access to the EZT-570S by placing it on the office LAN, also opens the door for accidental shutdown, damage to equipment, loss of data, lost time, etc. This is possible even by the most well-intentioned co-workers. Thus, there are several steps that should be taken to minimize this risk.

The first is to never mix your office LAN with your control LAN. The control LAN should be a separate network that consists of your environmental chamber(s) and possibly any other equipment that you may have that is related to the operation of the system. It should be separated from your office LAN by a firewall, or at minimum, a bridge or router. A control network and a business network have two entirely different purposes and their interaction should be closely controlled.

It is also unwise to assume that any Ethernet capable devices themselves have any security features at all. The EZT-570S VNC server only provides minimal single-password based security access. Separating the control LAN from the office LAN using a firewall would increase security and only allow control access that is based on a combination of IP source address, destination address, and port number. This is by no means completely 'hacker-proof,' but it should keep the well-meaning co-workers out.

Another hazard is connecting consumer 'plug and play' devices to your control LAN. A printer for example, might flood the network with traffic in a 'broadcast storm' as it tries to self-configure or advertise its presence to all nodes on the network. Faulty devices, for example defective NIC cards, can transmit large amounts of bad packets (i.e., runts, which are abnormally short Ethernet frames) into your network. Using switches instead of hubs will limit the effect of such problems.

The most commonly overlooked source of problems is cabling. Not all cables are created equal. Electrical noise generated by factory equipment or other electrical equipment in the area, could easily corrupt transmitted data over the network and cause devices to 'lock up' or shut down the VNC server, both of which then requires the EZT-570S to be shut down and restarted to clear the problem.

Select the right cable for the environment. Shielded twisted pair (STP) cable is naturally more noise immune and is preferable to unshielded twisted pair or UTP in noisy situations. STP should have at least 40dB CMRR and less than 0.1pF capacitance unbalance per foot. Ground STP cable, making sure the ground is connected only at one end. CAT5 STP patch panels normally provide a grounding strip or bar. Hubs and switches don't provide grounding, use cables.

It's wise to be pessimistic about a cable's ability to reject noise from 230 VAC and 460 VAC power lines and electrically 'noisy' equipment in the area. Capacitance imbalance in cables greater than 70pF per 100m can introduce harmonic distortion, resulting in bit errors. The cost of cable is quite small compared to total equipment cost, so if you're looking to save money, this is not a place to do it. Choose a well-designed cable to minimize bit-error rate after installation, and that will give faster throughput with fewer glitches.

9.3.2 The EZT-570S and Network Security

When most people think of security, they think of anti-virus programs and continuous operating system updates to ensure their system is running with the "latest-and-greatest" software. For consumer devices, this is well and good, but when it comes to industrial devices not so much. How many times has an update to the OS caused an issue with an existing program that for now some reason is not working correctly or crashes inexplicably? How about an anti-virus program updating its threat definitions and now sees an application as a potential threat and blocking it from operating? To have this occur on a control device could be catastrophic to a process. So how does the EZT-570S address these concerns while still providing threat protection?

The EZT-570S software validation uses a specific OS version and revision number as part of the validation process. WinCE is not the same as Win7, 10, etc. and does not support automatic updates since the OS must be installed in a specific portion of memory using a cable or SD with the device present. The OS layout is also specific to the hardware on the device. CSZ has never had an update to the OS unless the hardware changed on our units which required a driver (mostly third party) for the new hardware. This also provides stability since this is an industrial device that provides specific functionality without most of the "overhead" of the OS's that full PC's run.

Most security issues arise from browsing or opening an email attachment that carries harmful code. The EZT-570S does not support the addition of anti-virus software: however, the EZT-570S does not have a browser or an email server to receive emails or attachments. The FTP, FileWeb and DataWeb interfaces are also client based only. They transmit files and data to remote servers, but do not receive.

The EZT-570S writes data to a web page in memory that can be accessed by an external browser. This is a read only web page (from the remote browser) that contains process values, set points, event and current program data only. The internal web page data is written over with real time data every 30 seconds. The EZT-570S does not read any data from its internal web page so any corruption of the web page would not affect EZT-570S display/control operations. There are no passwords or sensitive data sent from the remote browser to the "read only" web page.

A virus to attack Windows CE would be difficult, but not impossible. Every Windows CE device is different (by manufacturer), so not an easy standard to write the virus against. The virus would need to be built for Windows CE and the CPU that the EZT-570S runs, and the storage device doesn't have a standard name. There might be industrial devices that run anti-virus on their CE devices; however, CSZ is not aware of any. As the saying goes, the best defense is a good offense. It is best to design a "smart network" to prevent intruders from gaining access in the first place than to try and fend them off once they are already in the door.

9.3.3 Using the Web Server

The EZT-570S's web server allows a user to remotely monitor chamber operations anywhere via a PC's standard web browser. When enabled, the web server provides a detailed status page of the EZT-570S's current operating conditions. The web server can be enabled and disabled by simply touching the "Www." button.

You must use the assigned IP address to access the EZT-570S. To obtain the correct IP address, go to the Communications screen selection under the device settings "Comm" menu. Write down the IP address so you will have it to enter into your web browser. You can also view the IP address by pressing the date/time field in the menu bar area to show the notifications window. The IP address is shown at the bottom of the notifications list.

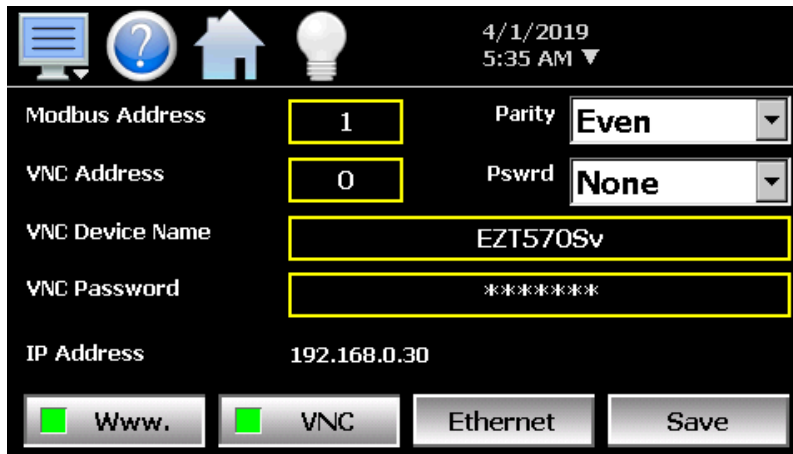

Figure 9-9 Web Server Settings

! Contact your IT department prior to enabling the web server of the EZT-570S. Company policy may prohibit the use of web servers for security reasons. We are not responsible for the use of, nor makes any claims as to the security of the web server interface over your network. The use of the EZT-570S web server is the responsibility of the end user.

To access and view the EZT-570S web page, enter the following link in your PC's browser address window: <http://IPaddress/ezt.html> (from example address, <http://192.168.0.30/ezt.html>). The following example is typical of the EZT-570S web page appearance. The web page updates automatically every 30 seconds and provides information on each individual loop, program status, alarm status and event status.

CINCINNATI SUB-ZERO - EZT-570S

CINCINNATI, OH - 513-772-8810

CONTROL DATA

TEMPERATURE	PV = 92.5	SP = 24.0
HUMIDITY	PV = 4.3	SP = 50.0
PRODUCT	PV = 32.6	SP = 24.0

AUTOMATED PROGRAM

Program Name	
Program Status	Inactive
Start Date-Time	00/00/00-00:00
Est. Complete Date-Time	00/00/00-00:00
Current Step	0
Remaining Step Time	00:00:00
Wait For	NOT WAITING
Wait For Setpoint	----
Jump Step	----
Jumps Remaining	----
TEMPERATURE Target SP	0.0
HUMIDITY Target SP	0.0
PRODUCT Target SP	0.0

SYSTEM ALARMS

SYSTEM EVENTS

CHAMBER	OFF
HUMIDITY	OFF
----	OFF
----	OFF
----	OFF
----	OFF

9.3.4 Using the VNC Server

The EZT-570S VNC server allows a user to remotely monitor and control the chamber by directly viewing and manipulating the touch screen over the network. You must use the assigned IP address and VNC port number to access the EZT-570S. The IP address is shown on the communications screen and is also included in the notifications list. Write down the IP address and port number so you will have it to enter into your VNC viewer.

There are many VNC viewers available for both PC and tablet use. Due to the ever-changing market and availability of such applications, it is not possible to test them all for compatibility or provide assistance for their use with the EZT-570S. It is the responsibility of the end user to test the chosen VNC client for compatibility with the EZT-570S prior to putting the unit into service. If the VNC client viewer has compatibility issues with the EZT-570S, it can cause the VNC server to stop responding and/or shut down requiring power to be cycled to the chamber in order to reboot the system and restart the server.

CSZ has tested and recommends the use of RealVNC's viewer. It has been tested for compatibility with the EZT-570S and a free version can be obtained from <http://www.realvnc.com/> for PC/MAC use. RealVNC does offer a version for the iPad that can be obtained through the App Store for a small fee. The App Store also offers a free VNC client called Remotix for the iPad. It has also been tested for compatibility with the EZT-570S.

! *Contact your network administrator prior to enabling the VNC server of the EZT-570S. Company policy may prohibit the use of VNC servers and/or viewers for security reasons. CSZ is not responsible for the use of, nor makes any claims as to the security of the VNC server interface over your network. The use of the EZT-570S VNC server is the responsibility of the end user.*

9.3.4.1 Recommended VNC Viewer Settings (PC/MAC)

This section applies to setup of the recommended RealVNC viewer for PC/MAC. These settings have been tested and evaluated in order to provide the best performance and quickest response to user input when using the VNC viewer with the EZT-570S. After installing the VNC viewer software, it is recommended that the following changes be made to the default viewer settings.

To begin, start the VNC viewer. Click on the 'Options' button in order to open the 'VNC Viewer - Options' window.

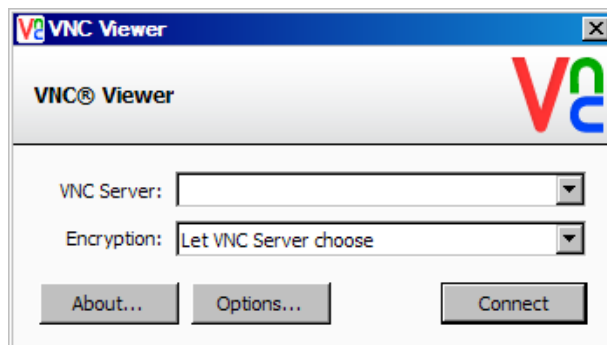

Click on the 'Advanced' button at the bottom left of the window in order to show the advanced setup options. On the 'Display' tab, make sure the scaling is set to 'No scaling' and the checkbox for 'Adapt to network speed (recommended)' is checked.

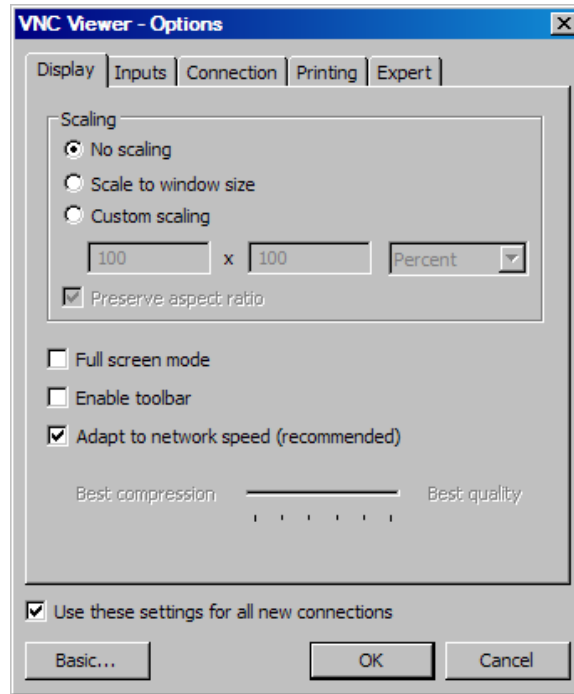

Next, select the 'Inputs' tab and deselect all entries except for 'Enable mouse input' and 'Rate-limit mouse move events'. The 'Inputs:' drop down selection box will automatically change to 'Custom' when the settings are made.

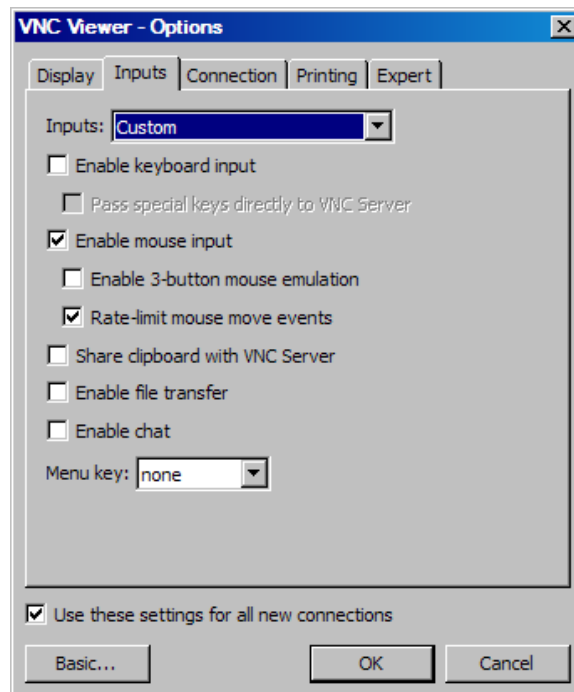

Proceed to the 'Expert' tab and scroll down the list of settings until you find the 'FullColour' option. It is recommended that this option be set to true. If set to false, the EZT-570S screen may not be shown properly in the client window. Locate the 'PreferredEncoding' and 'Protocol3.3' options further down the list and set the preferred encoding to Hextile and the Protocol 3.3 option to true.

Verify that the 'Use these settings for all new connections' checkbox at the bottom of the window is checked and click the OK button. This will set the selections to the default start settings for the VNC viewer.

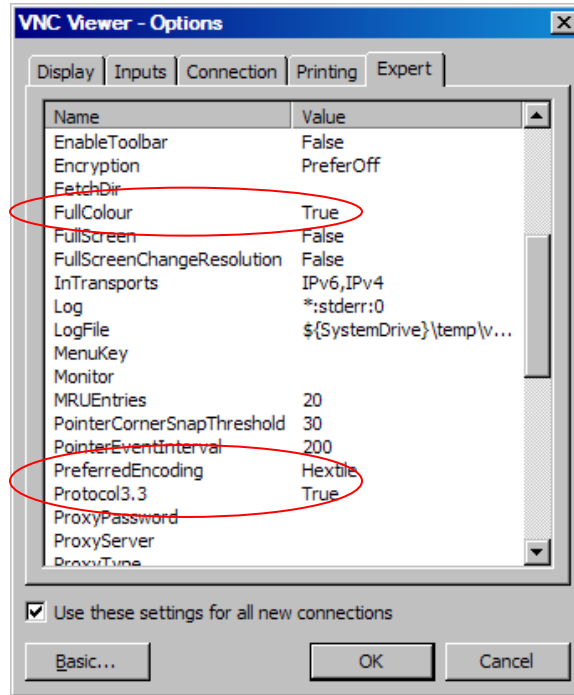

9.3.4.2 Recommended VNC Viewer Settings for Tablets

The VNC clients for tablets have been found to offer limited flexibility for use with the EZT-570S. Most clients have default settings requiring security to be enabled on the server in order to connect. If you have trouble connecting with a VNC viewer through an iPad, iPhone or even an Android based phone, start by enabling the security on the EZT-570S VNC server and be sure to enter those settings in the client viewer.

Color and encoding options can also affect the connectivity. If the client offers the option, leave color and encoding options to 'automatically detect' or 'server decides'. If the client is still unable to connect, try default encoding of Hextile and set the color option to limited colors such as 256-bit color. We do not write or create VNC clients (3rd party software), so final selection of the client and testing is the end user responsibility.

The following settings are provided as an example for the Remotix client for the iPad. When adding an EZT-570S server to the Remotix client, use the following settings. Note that the VNC server in the EZT-570S must have security enabled in order for this client to connect.

Connection Type: VNC
 Host/IP: IP address of the EZT-570S
 Port: VNC address of the EZT-570S (5900 = 0, 5901 = 1, etc...)
 Use SSH Tunnel: Off
 VNC Authentication: VNC Password
 VNC Password: VNC password of the EZT-570S
 VNC Server Type: AutoDetect
 Operating System: Windows
 Preferred Encodings: Hextile
 Color Depth: 16 bits

9.3.4.3 Accessing the EZT-570S through a VNC Viewer

The following examples are based on the use of the RealVNC viewer for PC/MAC. Once the default settings have been entered, just enter the IP address and port number for the EZT-570S and click the 'Connect' button to access the chamber over the network.

Intranet Example: If the IP address assigned is 192.168.3.5 and the configured VNC Address is 1, from the PC's VNC Viewer address field, enter '192.168.3.5:1' (address 1 relates to port 5901, address 2 to port 5902, etc., which is the port opened by the VNC interface in order to allow communications with the EZT-570S over the network).

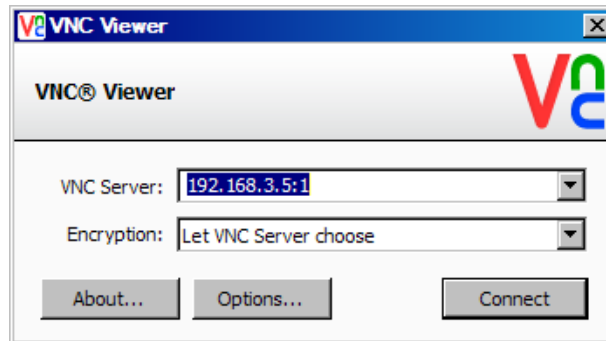

Internet Example: Internet connection typically requires a qualified network System Administrator. Typically, a permanent IP address and specific port address are assigned to the EZT-570S; support on this action is beyond the scope of this guide. *Consult your network system administrator for assistance in setting up an Internet connection.*

If the IP address of the LAN is 69.216.64.69 and the configured VNC Address is 1 (port 5901 has been opened and assigned to this specific EZT-570S), from the remote PC (outside of the site Servers LAN), in the VNC Viewer address field enter '69.216.64.69::5901' (5901 relates to address 1, 5902 to address 2, 5903 to address 3, etc., note the double colon).

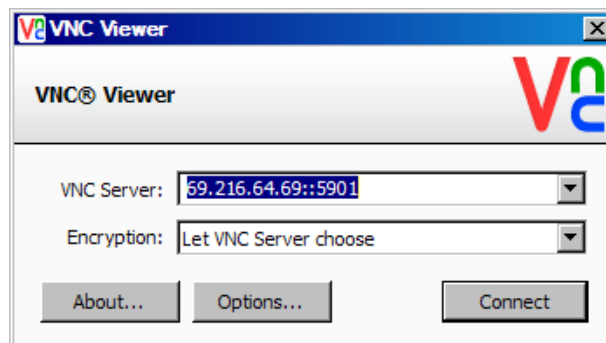

 *The IP address shown on the communications screen of the EZT-570S is the LAN address and would not typically be used for an Internet connection.*

Security Example: If the VNC server password is enabled on the EZT-570S, for either example above, upon pressing the 'Connect' button to make the connection, the VNC viewer will prompt for the proper password. The connection will only be established once the valid password is entered.

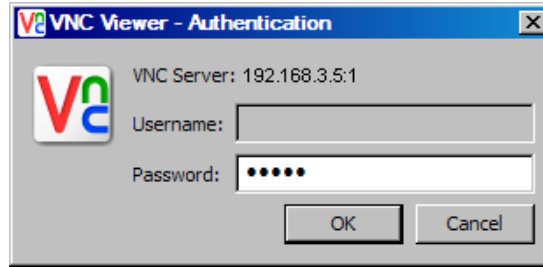

Once the connection is established, a duplicate image of the current EZT-570S display will be shown on your desktop. As you manipulate the screen, the display of the EZT-570S will also be manipulated so that any local operator will be able to see what is happening and vice versa.

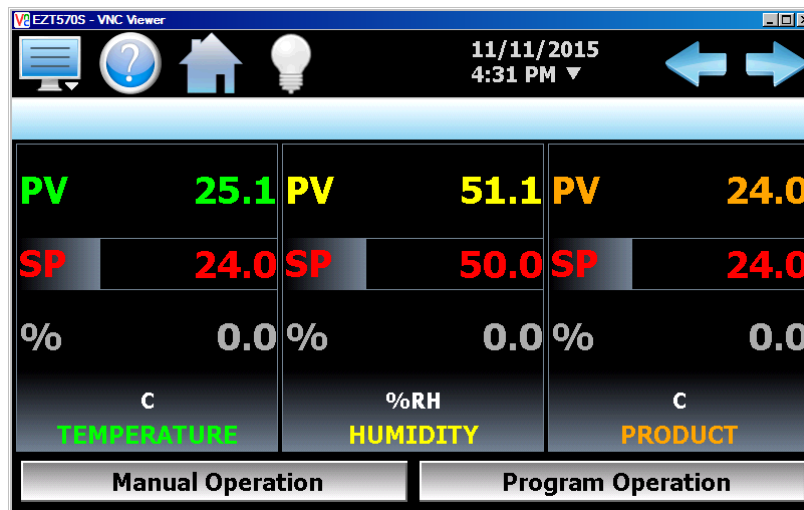

Multiple instances of the VNC viewer can be started on your PC. By running multiple viewers, you can have access to multiple chambers right from your desktop. The heading of each VNC viewer window will use the 'VNC Device Name' entry for the header. By entering a unique name for each EZT-570S, you can identify each VNC connection and know which chamber you are accessing.

The VNC viewer is meant to be used for short term control access. It is not meant for long term monitoring of chamber operation. If long term monitoring access is desired, use the built-in web server of the EZT-570S or a PC with EZ-View software to monitor and control the EZT-570S over its serial communications port. The web server interface and PC software is designed for long term monitoring and status updates.

Due to the nature of VNC operation, and for security reasons, the VNC viewer connection should not be left open on your desktop. The viewer connection should be opened in order to perform the necessary control and/or status check of system operation, and then closed once the task is complete. Accidental manipulation of the control or erroneous network activity could cause connection problems over the VNC interface and result in the VNC server shutting down and requiring the EZT-570S to be repowered in order to regain access.



Some viewers may also contain additional features for file transfer and other high-level functions. These functions are NOT compatible with the EZT-570S. Any attempt to use them may cause the VNC server to malfunction and require power to be cycled in order to reboot the EZT-570S. All viewers should be used ONLY to monitor and manipulate the EZT-570S as if you were standing directly in front of it.

9.3.5 Using Modbus TCP/IP Communications

The EZT-570S Modbus TCP server interface allows a user to remotely monitor and control the chamber via another device or software application compatible with Modbus TCP/IP protocol. The acronym TCP stands for Transmission Control Protocol while IP stands for Internet Protocol. These protocols are used together and handle the transfer of data over the internet. When Modbus information is sent using these protocols, the data is passed to the TCP layer where additional information is attached and then passed to the IP layer. The IP layer then places the data in a packet (or datagram) and transmits it.

Like the EZT-570S Modbus serial interface, the TCP interface is always active; however, rather than using the Modbus Address on the communications screen as the slave address, the EZT-570S IP address is used as the slave address. In order for Modbus TCP communications to function, the Master (or Client in Modbus TCP) establishes a connection with the Slave (or Server) using the IP address. In this case, the server is the EZT-570S. The EZT-570S waits for an incoming connection from the client, and once a connection is established, the EZT-570S then responds to queries from the client until the client closes the connection.

In order for a client to establish a connection with the EZT-570S, the following settings must be used by the client:

IP address (of slave) =	EZT-570S IP address as displayed on the Communications screen
Unit Identifier =	EZT-570S Modbus Address as displayed on the Communications screen.
Port Number =	502



The implementation and/or use of a Modbus TCP client is outside the scope of this manual. For additional information regarding Modbus TCP/IP protocol there are many resources available online (<http://www.modbus.org/specs.php>) or consult the documentation provided with your client software application.

For a list of supported functions and data available over the Modbus TCP interface, see the EZT-570S User Communications Reference Manual.

10. Diagnostics

This section provides technical help for diagnosing problem conditions with your chamber. The information provided here covers typical options and accessories. If you are unable to diagnose a problem through the use of this guide, contact our Service Department.

Please have the following information available:

- Model # and Serial # for the chamber
- Software Version #'s
- All User Manuals

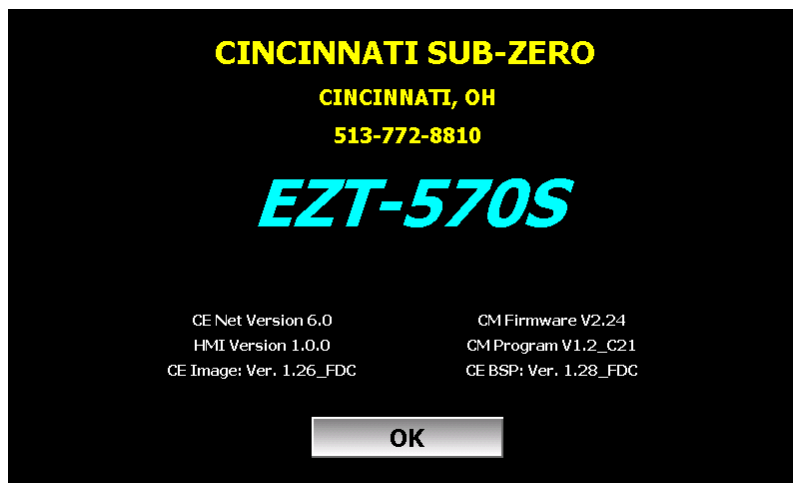

The software versions can be found on the “About” screen under the offline system menu.





10.1 Alarm Codes and Troubleshooting



Some of the procedures may require access to live circuitry. Dangerous accidental contact with line voltage is possible. Only qualified service personnel should be allowed to perform these procedures. Potentially lethal voltages are present inside the unit.

Alarm Monitor Description	Corrective Action
"Input" ALARM	User alarm is on for "input" listed. Allow process value to return within set point limits, change alarm set point values or disable alarm.
BOILER OVERTEMP	Boiler exceeded maximum operating temperature. Check water supply and water level. Verify low water float operation. Reset high temperature safety on boiler.
BOILER LOW WATER	Boiler water level low. Check water supply pressure. Check low float operation. Check operation of fill level float and water supply solenoid if applicable. Check and replace filters if necessary.
CHAMBER HI LIMIT	Chamber high limit safety tripped. Limit must be manually reset or power cycled to chamber to reset. Verify proper air flow and operation of air circulators in chamber. Reduce set point. Do not attempt to operate above chamber design limits.
Communications read error. Check communication cable.	<p>Communication wiring between HMI and PLC faulty or not properly connected. If alarm will not clear, check wiring. Exit EZT-570S application and verify that COM1 serial port is set to RS485.</p> <p>If intermittent alarm (can be cleared and returns at random intervals), then remote PC communicating too fast with EZT-570S. Reduce rate at which PC sends commands to the EZT-570S or reduce number of communication connections.</p> <p> <i>Random alarms when communications are being used are not a sign of a hardware problem. It indicates that the EZT-570S is being loaded down with excess work. The purpose of the EZT is to control the chamber. Maintain a reasonable level of interface activity in order to keep your chamber running at an optimum condition.</i></p> <p><i>Intermittent alarms do not affect the operation of the chamber or shut down the chamber. However, data logging may be affected depending upon the logging rate selected. No audible alert is associated with this alarm.</i></p>
DEHUMID SYSTEM FAULT	Optional dehumidifier system fault. Check manufacturer's manual provided with the chamber for troubleshooting and diagnostic information.
Email Error! Check cable or server down.	<p>Indicates that the EZT-570S was unable to send an alarm message through the mail server. Verify that the EZT-570S is properly connected to the network and that the email server entered is valid.</p> <p> <i>This alarm does not affect chamber operations. It is an indication only alarm. No audible alert is associated with this alarm.</i></p>
EMERGENCY STOP	Investigate cause of stop. Verify conditions are safe. Reset emergency stop. Will require manual restart of chamber via

Alarm Monitor Description	Corrective Action
	Overview screen or resuming program operation if an automatic ramp/soak program was operating when stop occurred.
FLUID SYS TEMP	Fluid system high temperature safety tripped. Limit must be manually reset or power cycled to chamber to reset. Verify fluid level and flow. Do not set temperature set point above fluid system design limits.
FLUID SYS HI PSI	Fluid system exceeded operating pressure limits. Check for restrictions in fluid system. Verify all isolation valves are open. Reset high pressure safety.
FLUID SYS LOW FLOW	Fluid flow safety tripped. Verify fluid level. Check for restrictions in system. Check pump operation and service if necessary.
FTP! Check cable or server down.	<p>Indicates that the FTP back-up attempt of the data files failed. Verify that the EZT-570S is properly connected to the network and that the FTP site is valid.</p> <p> <i>This alarm does not affect chamber operations. It is an indication only alarm. No audible alert is associated with this alarm.</i></p>
LOOP COMMS FAILURE	Check communication wiring between the CPU module and 9300 loop controls. Verify proper addresses on 9300 controllers. Verify power to 9300 controllers. Check rear terminal plug on 9300 controllers and make sure it is seated properly.
MOTOR OVERLOAD	Motor overload tripped or motor drive fault. Requires manual reset of motor overload. Check drive and motor fusing. Check motor for overload condition, i.e., bearing wear binding shaft, etc. Replace fuse, repair/replace motor or drive.
NTS Ping Failed. Check Cable.	<p>Indicates that the EZT-570S was unable to synchronize its clock with the selected national time server. Verify that the EZT-570S is properly connected to the network and time server selected is accessible.</p> <p> <i>This alarm does not affect chamber operations. It is an indication only alarm. No audible alert is associated with this alarm.</i></p>
PHASE MONITOR	<p>When equipped with a phase monitor (typically 3.5HP or 6HP scroll refrigeration systems), this alarm indicates a fault with the chamber's main power source. Check for proper phase sequence, phase loss or voltage imbalance between phases. Check system 1 compressor fuses, replace if necessary.</p> <p>The chamber will not operate until proper power input is obtained.</p>
POWER FAILURE	When equipped with an optional UPS back-up for the control system, this alarm indicates a main power failure. The EZT-570S will then automatically restart the chamber when main power is restored.
PRODUCT SAFETY	Optional product safety limit tripped. Manually reset limit to clear alarm. Check limit set points and verify properly set for product testing.

Alarm Monitor Description	Corrective Action
PUMPDOWN DISABLED	Chamber power off for more than 30 minutes. Will automatically reset in 4 hours. Can be manually reset via alarm monitor screen. Unit will not run with pumpdown disabled.
"Input" SENSOR BREAK	Check sensor wiring for indicated "input". Verify lead connections. If sensor requires power, i.e., humidity, altitude, etc., verify power to sensor. Replace sensor.
SYS# HILO PSI	Refrigeration system # (# = system number) high or low pressure safety tripped. High pressure safety requires manual reset. Check condenser for blockage, clean if necessary. Low pressure will automatically reset. Check static pressure for possible leaks. Service and further diagnostics require authorized, certified refrigeration service personnel.
SYS# LOW OIL PSI	Refrigeration system # (# = system number) oil pressure safety tripped. Check compressor oil level. Requires manual reset. Service and further diagnostics require authorized, certified refrigeration service personnel.
SYS# HI DISCHARGE	Refrigeration system # (# = system number) discharge safety tripped. Check liquid injection solenoid. Automatically resets. Service and further diagnostics require authorized, certified refrigeration service personnel.
SYS# COMP MONITOR	Refrigeration system # (# = system number) compressor protection module tripped. Check fusing and contactor for proper operation. Automatically resets after approximately 30-45 minutes. Service and further diagnostics require authorized, certified refrigeration service personnel.
TRANSFER ERROR	Transfer fault. Check for mechanical obstructions in basket transfer mechanism. Verify proper sensor locations and operation for proper basket position indication.



An audible alarm will sound for all system alarms other than the indication only alarms noted. The audible alarm can be disabled for loop and monitor alarms if desired by selecting the "Silent" alarm mode, see Section 5.4 Alarms.

System Status Monitor Description	Corrective Action
RH H2O RESERVOIR LO	Optional Humidity water reservoir low. Add more water. (an audible alert is associated with this indicator)
RH TMP DISABLE	Temperature outside allowable humidity operational limits. Turn off humidity system or set temperature set point within proper operating range. (no audible alert is associated with this indicator)
RH HI DEWPOINT LIMIT	EZT-570S is limiting the maximum humidity level based on the maximum allowable dewpoint that the chamber can operate safely without causing potential damage to the structure of the chamber. Set temperature and humidity set points to within allowable chamber range. (no audible alert is associated with this indicator)
RH LO DEWPOINT LIMIT	EZT-570S is limiting the minimum humidity level based on the minimum allowable dewpoint that the chamber can operate safely without causing potential damage to the refrigeration system. Set temperature and humidity set points to within allowable chamber range. (no audible alert is associated with this indicator)
DOOR AJAR	Chamber door is open. If the chamber is equipped with a door switch to stop chamber operations when open, the indicator will be lit.
SERVICE FANS	Service alert, if enabled, indicating that the prime air movers of the chamber require regular maintenance. Perform service and clear elapsed service count for corresponding components.
SERVICE REFRIGERATION	Service alert, if enabled, indicating that the heating and/or cooling system components require regular maintenance. Perform service and clear elapsed service count for corresponding components.
SERVICE HUMIDITY	Service alert, if enabled, indicating that the humidity system components require regular maintenance. Perform service and clear elapsed service count for corresponding components.
SERVICE PURGE	Service alert, if enabled, indicating that the dry air purge system components require regular maintenance. Perform service and clear elapsed service count for corresponding components.
SERVICE ALTITUDE	Service alert, if enabled, indicating that the altitude system components require regular maintenance. Perform service and clear elapsed service count for corresponding components.
SERVICE TRANSFER CART	Service alert, if enabled, indicating that the basket transfer mechanism components require regular maintenance. Perform service and clear elapsed service count for corresponding components.

 *An audible alarm can be associated with the service alerts. See Section 10.2, Service Monitors, for detailed information on the service alerts.*

10.2 Service Monitors



Perform lock-out, tag-out procedures and remove main power from the chamber prior to performing any service procedures. Service should only be performed by qualified service personnel.

Elapsed Service Counter Description	Service Action
AIR CIRCULATOR HRS	<p>Inspect locking collars on fans. Tighten if necessary.</p> <p>Inspect fan blades for damage and/or loose blades. Replace fan blade if necessary. DO NOT attempt repair.</p> <p>Inspect motor bearings for excessive wear (slop). Lubricate if applicable.</p> <p>Inspect heaters for corrosion and replace if insulators are cracked or damaged.</p>
RC BLOWER HRS	<p>Inspect locking collars on blower wheel. Tighten if necessary.</p> <p>Inspect blower wheel for damage and/or loose blades. Replace wheel if necessary. DO NOT attempt repair.</p> <p>Inspect motor bearings for excessive wear (slop). Lubricate if applicable.</p>
ALTITUDE SYS HRS	<p>Change vacuum pump oil filter.</p> <p>Check oil level in vacuum pump. Check for leaks. Add oil if needed.</p> <p>If applicable, inspect drive belts and replace if worn. Re-tension belts. Inspect motor bearings for excessive wear (slop). Lubricate if applicable.</p>
SYS # COMPRESSOR HRS	<p>Check compressor oil level. Verify static pressures.</p> <p>Clean air-cooled condenser if applicable (air cooled units).</p> <p>Inspect condenser water connections if applicable (water cooled units). Verify proper temperature and differential pressure.</p>
HUMIDITY SYSTEM HRS	<p>Inspect water connections and filter cartridge if applicable.</p> <p>Clean humidity water reservoir if option present.</p> <p>If atomizer system, remove spray nozzle and clean. Inspect compressor motor and diaphragm for wear. Clean water filter.</p> <p>Inspect for build-up of deposits on humidity sensor. Clean filter tip of sensor. Use caution so as not to damage sensor tip.</p>
DRY AIR PURGE HRS	<p>Inspect air lines for leaks.</p> <p>Inspect filters and clean if necessary.</p>
HEATER CYCLES	<p>Inspect electrical connections and heater SSR for loose or frayed wiring. Tighten loose connections.</p>
SYS # CMP STARTS	<p>Inspect wiring and power contactors for loose connections. Tighten or repair as necessary.</p>

Elapsed Service Counter Description	Service Action
	Inspect compressor mounts/vibration isolators for wear. Tighten loose mounts or replace isolators if worn.
COOL VALVE CYCLES	Inspect valve body for corrosion. Look for cracks in valve stems. Inspect electrical connections on solenoid coil. Requires authorized refrigeration service personnel to replace.
RHCOOL VALVE CYCLES	
HUMIDIFY CYCLES	If boiler system, inspect electrical connections and heater SSR for loose or frayed wiring. Tighten loose connections.
DEHUMIDIFY CYCLES	Inspect valve body for corrosion. Look for cracks in valve stems. Inspect electrical connections on solenoid coil. Requires authorized refrigeration service personnel to replace.
LOW RH VALVE CYCLES	
DIVE VALVE CYCLES	Inspect valve body and fittings for cracks or leaks Verify pressure regulator settings.
VACUUM VALVE CYCLES	
TRANSFER CYCLES	Inspect transfer mechanism for wear. Adjust slide mechanisms and/or lubricate as necessary. Inspect cables for fraying and replace if applicable.



The elapsed service intervals are set based on CSZ recommended operating conditions for the chamber. These intervals may not be suitable to all applications due to varying operating conditions and environmental factors. It is recommended that these be used as a guide only, and that the end user determine and set up their own maintenance program based on use to insure reliable and long-term chamber operation.

If you have any questions regarding maintenance procedures or would like recommendations for service procedures or programs, contact our Service Department.

Appendix

FTP, FileWeb, DataWeb Requirements/Installation

Introduction

The following describes the system requirements and components for the Cloud service and website. The cloud service provides the ability to upload data from controllers to cloud storage for backup and/or further analysis. The website provides the ability to verify data, uploads, and to manage users.

System Overview

There are four server components; the data transfer service (CSZDataService), the website (CSZDataWeb), the FTP server, and a MySQL database. CSZDataService and CSZDataWeb are Microsoft .Net services, and use Microsoft Internet Information Services (IIS) as a web platform. The MySQL (Can be SQL, Oracle, etc.) database stores user configuration information as well as providing cloud data storage if desired.

System Requirements

A Microsoft Windows server is required, with the following minimum capabilities:

- Windows Server 2008 or greater
- 2 GB RAM or greater
- 2 Cores or greater
- 40GB Storage or greater (this will vary depending on the user's expected uploads)
- .Net framework version 4.5 or greater
- MySQL 5.6 or greater

The server should be setup to provide the web server role.

Cloud "Server" Services

Cincinnati Sub Zero does not provide direct support or hosting services; however, third party support is available from our partner **Mooseworks Software** which can provide:

1. Complete site and installation without hosting charges (includes CSZ site with custom banner, site setup, all code/data model definitions and manual). User provides the server and hosting credentials including domain name and https certificate.
 2. Purchase of #1 above with hosting using Amazon Web Services (AWS). AWS T2 small server with 30GB storage. User provides the domain name and https certificate. Support cost on a yearly basis.
 3. Purchase of #1 above with no hosting but support of client server at customer facility or customer selected location. Support cost on a yearly basis for web service and application.
 4. DIY documentation – interface/data model definitions and server setup directions. DIY experience recommendations include installation and configuration of web servers, web services, SQL language and HTML/.NET code. Support packages for DIY documentation can be purchased in 5, 10 and 25 hour increments.
- Custom development services:
 - Fixed pricing available for well-defined systems.
 - Time and material options available for less defined, continuous engagements.

For more information please contact Cincinnati Sub Zero support for assistance.

Common Terms and Definitions

Autotune — A feature that automatically sets process control PID values to match a particular process in a system.

Baud rate — The rate of information transfer in serial communications, measured in bits per second.

Accuracy — Closeness between the value indicated by a measuring instrument and a physical constant or known standard.

Offset — An adjustment to eliminate the difference between the indicated value and the actual process value.

Cascade — Control algorithm in which the output of one control loop provides the set point for another loop. The second loop, in turn, determines the control action.

Derivative control (D) — The last term in the PID control algorithm. Action that anticipates the rate of change of the process, and compensates to minimize overshoot and undershoot. Derivative control is an instantaneous change of the control output in the same direction as the proportional error. This is caused by a change in the process variable (PV) that decreases over the time of the derivative (TD). The TD is in units of seconds.

DHCP (Dynamic Host Configuration protocol) — Permits auto-assignment of temporary IP addresses for new devices logging in to the network.

DNS (Domain Name Server) — Associates names with IP addresses over a network.

Droop — In proportional controllers, the difference between set point and actual value after the system stabilizes.

EIA — See Electronics Industries of America.

EIA/TIA -232 and -485 — Data communications standards set by the Electronic Industries of America and Telecommunications Industry Association. Formerly referred to as RS- (Recognized Standard).

Electronics Industries of America (EIA) — An association in the US that establishes standards for electronics and data communications.

FTP (File Transfer Protocol) — The most popular mechanism for bulk movement of files on TCP/IP.

Fuzzy logic — A mathematical control algorithm that monitors past response of a system to predict future response and automatically adjust PID parameters in order to adapt to process.

Hysteresis — A change in the process variable required to re-energize the control or alarm output. Sometimes called switching differential.

Integral control (I) — Control action that automatically eliminates offset, or droop, between set point and actual process temperature.

IP Address — Address of a TCP/IP enabled device on an Intranet or Internet.

LAN (Local Area Network) — A group of computers and associated devices that share a common communications line or wireless link.

Common Terms and Definitions (cont'd)

Limit or limit controller — A highly reliable, discrete safety device (redundant to the primary controller) that monitors and limits the temperature of the process, or a point in the process. When temperature exceeds or falls below the limit set point, the limit controller interrupts power through the load circuit. A limit controller can protect equipment and people when it is correctly installed with its own power supply, power lines, switch and sensor.

MAC (Media Access Control) — The physical components which disassemble Ethernet message frames.
MAC Address — The physical address of an Ethernet node.

Modbus™ — A digital communications protocol owned by AEG Schneider Automation for industrial computer networks.

Modbus™ RTU — Remote Terminal Unit, an individual Modbus™-capable device on a network.

Overshoot — The amount by which a process variable exceeds the set point before it stabilizes.

PID — Proportional, integral, derivative. A control mode with three functions: proportional action dampens the system response, integral corrects for droop, and derivative prevents overshoot and undershoot.

Process variable (PV) — The parameter that is controlled or measured. Typical examples are temperature, relative humidity, altitude, etc. The high process variable is the highest value of the process range, expressed in engineering units. The low process variable is the lowest value of the process range.

Proportional control (P) — Output effort proportional to the error from set point. For example, if the proportional band is 20° and the process is 10° below set point, the heat proportioned effort is 50 percent.

Ramp — A programmed increase in the temperature of a set point system.

Range — The area between two limits in which a quantity or value is measured. It is usually described in terms of lower and upper limits.

(RTD) resistance temperature detector — A sensor that uses the resistance temperature characteristic to measure temperature.

Serial communications — A method of transmitting information between devices by sending all bits serially over a single communication channel.

Set point (SP) — The desired value programmed into a controller. For example, the temperature at which a system is to be maintained.

TCP/IP (Transmission Control protocol / Internet protocol) — A suite of commands used for handling the transmission of Internet data.

(T/C) thermocouple — A temperature sensing device made by joining two dissimilar metals. This junction produces an electrical voltage in proportion to the difference in temperature between the hot junction (sensing junction) and the lead wire connection to the instrument (cold junction).

List of Figures

Figure 1-1 DUT Safety Connections 6

Figure 1-2 Touch Screen Interface 8

Figure 1-3 Text Based Navigation 9

Figure 1-4 Icon Based/Slide Navigation..... 9

Figure 1-5 Notifications 18

Figure 2-1 Main View (one loop)..... 19

Figure 2-2 Main View (three loop)..... 19

Figure 2-3 Overview..... 20

Figure 2-4 Real-Time Trend..... 21

Figure 2-5 Trend Setup..... 22

Figure 2-6 Trend Time/Axis..... 22

Figure 2-7 Alarm Monitor 23

Figure 2-8 Alarm Help..... 24

Figure 2-9 Alarm History 25

Figure 2-10 System Status Monitor 26

Figure 3-1 Single Set Point Adjustment..... 27

Figure 3-2 Numeric Entry..... 27

Figure 3-3 Manual Event Control (Overview)..... 28

Figure 3-3 Manual Event Control (Main)..... 28

Figure 4-1 Program Entry..... 35

Figure 4-2 Step Time Entry..... 36

Figure 4-3 Set Point (Ramp Rate) Entry 37

Figure 4-4 Program Step Events 39

Figure 4-5 Program Soak Events..... 39

Figure 4-6 Program Wait For 40

Figure 4-7 Program AutoStart..... 42

Figure 4-8 Guaranteed Soak Limits 43

Figure 4-9 Program Plot..... 43

Figure 4-10 Program List 44

Figure 4-11 Program Operation 44

Figure 4-12 Program Start Step..... 45

Figure 4-13 Program Status..... 46

Figure 4-14 Adjust Step Time 47

Figure 5-1 Power Recovery 51

Figure 5-2 Set Point Limits..... 52

Figure 5-3 Event Names 52

Figure 5-4 Alarm Settings 53

Figure 5-5 Alarm Set Points and Message 55

Figure 5-6 Product Control..... 56

Figure 5-7 Condensation Control..... 61

Figure 5-8 Defrost Settings 62

Figure 5-9 Communication Settings..... 63

Figure 5-10 Ethernet Settings 64

Figure 5-11 Barcode Reader..... 65

Figure 5-12 Create Email Address..... 67

Figure 5-13 Email Addresses..... 68

Figure 5-14 Email Settings..... 68

Figure 5-15 Send Email Message..... 70

Figure 5-16 Select Email Address	70
Figure 5-17 Navigation	71
Figure 5-18 Tuning	72
Figure 6-1 Security (New User)	75
Figure 6-2 Security (Users)	75
Figure 6-3 Change User Password	76
Figure 6-4 User Access Rights	76
Figure 6-5 Security Options	79
Figure 6-6 Audit Trail View	80
Figure 7-1 Assign Log Points	82
Figure 7-2 Start/Stop Data Logging	82
Figure 7-3 Plot Channels	84
Figure 7-4 Plot Time	85
Figure 7-5 Historical Plot	85
Figure 7-6 Historical Plot Legend	86
Figure 7-7 USB File Transfer	87
Figure 7-8 FTP/WAN Setup	89
Figure 7-9 Annotation	98
Figure 7-10 Digital Signatures	99
Figure 8-1 Service Monitors	101
Figure 8-2 Service Options	102
Figure 8-3 Temperature Units Selection	103
Figure 8-4 Adjust Time	104
Figure 8-5 Time Options	104
Figure 8-6 Daylight Savings	105
Figure 8-7 Language	106
Figure 8-8 Special Settings	107
Figure 8-9 Analog Inputs	107
Figure 8-10 Analog Input Loop Select	108
Figure 8-11 Analog Input Wiring	109
Figure 8-12 Analog Outputs	110
Figure 8-13 Analog Output Wiring	111
Figure 8-14 Digital Inputs	112
Figure 8-15 Digital Input Functions	113
Figure 8-16 Digital Input Wiring	115
Figure 8-17 Digital Outputs	116
Figure 8-18 Digital Output Functions	116
Figure 8-19 Digital Output Wiring	119
Figure 8-20 Monitor Offset calibration	120
Figure 8-21 Display Settings	121
Figure 8-22 Display Calibration	122
Figure 8-23 Display Properties	123
Figure 8-24 Advanced Backlight Options	124
Figure 8-25 Configuration	124
Figure 8-26 About EZT-570S	127
Figure 8-27 Exit Application	128
Figure 9-1 Communications Connector	129
Figure 9-2 Modbus Settings	130
Figure 9-9 Web Server Settings	137